

# 14

## PRESSURE GAUGES, FLOW, VACUUM & TEST

This section includes high-pressure, dry, glycerine, vacuum, and liquid gauges for measuring pressure. Vacuum products include suction cups and sight flow indicators. Leak and pressure testing products include specialist connectors.

### PRESSURE GAUGES

#### PARKAIR®



839  
Dry Pressure  
Gauges –  
Dual Scale



840  
Dry Vacuum  
Gauges



841  
Stainless Steel  
Glycerine  
Filled Gauges  
– Dual Scale &  
Accessories



842  
High Pressure  
Glycerine Filled  
Gauges

#### HYDROTECHNIK UK TEST ENGINEERING LTD



843  
Stainless Steel  
Glycerine Filled  
Gauges



844  
Digital Pressure  
Gauges & Pressure  
Gauge Accessories



846  
Pressure Testing Kits



847  
Test Point Products

### FLOW

#### RHODES



852  
Sight Flow Indicators

#### PVL Engineers Scaling Engineers



853  
Pressure Switches



854  
Pressure &  
Temperature  
Switches

#### PVL Engineers Scaling Engineers



855  
Vacuum Switches







855  
Level Switches







855  
Float Valves

## VACUUM





				
856 Vacuum System & Suction Cup / Grippers Introduction	858 Suction Cups – MX Range	860 piGRIP Suction Cups	861 Bag & Pouch Opening	862 Suction Cups – U, F, B, Duraflex OB, Duraflex BX, Duraflex BL Ranges



				
865 FDA Approved Suction Cups – F-FDA, B-FDA Ranges	866 Suction Cups – B-BL, F-BX & F-OB Food Ranges	867 Value Line Brass Fittings	868 piINLINE® Vacuum Ejectors	869 piSAFE® Range





		
869 Kenos® Vacuum Gripping System	871 Vacuum Filters	872 End Of Arm Tooling Components (EOAT)

## TEST



				
875 EZ Connect ZN Series	876 EZ Connect ZF Series	878 FE Series External Connectors	879 FI Series Internal Connectors	881 JNL / JXL Series



	
882 FasMate FX / FN Series	884 TwistMate MET / MIT Series



# Pressure Gauges

A pressure gauge is essential for accurately measuring and displaying the pressure of fluids or gases in a system. It is crucial to ensure the system functions optimally by constantly monitoring its pressure build-up. Pressure gauges are designed to withstand high pressures and operate efficiently over an extended period, making them an asset in various industrial settings.

Pressure gauges come in different sizes and types, depending on the application and pressure range to be measured. Our dual-scaled range of pressure gauges from PARKAIR®, CEJN, and Hydrotechnik UK includes dry vacuum, dry pressure, glycerine-filled and high-pressure gauges. They are widely used in many industries, including refineries, electrical and industrial plants, healthcare, energy production, manufacturing, automotive, and aerospace.

Dry vacuum gauges measure the pressure below atmospheric pressure, while dry pressure gauges measure the pressure above atmospheric pressure. Glycerine-filled gauges can measure pressure over a wide range of temperatures and pressures. Digital pressure gauges are the best option for measuring pressure in extreme temperatures, hazardous environments, constant pressure pulsation and heavy mechanical vibration.

Please choose the correct pressure gauge for any application with our analogue and digital gauge selection.



CENTRE BACK CONNECTION

BOTTOM CONNECTION



4600



4600

STEEL CASE, DRY GAUGES  
40 MM GAUGE DIAMETER

PART NUMBER	THREAD	MAX. PRESSURE SCALE	PRICE
Y001540B2D	1/8" BSPT	0 – 1 bar / 0 – 15 psi	£13.46
Y003040B2D	1/8" BSPT	0 – 2 bar / 0 – 30 psi	£13.46
Y006040B2D	1/8" BSPT	0 – 4 bar / 0 – 60 psi	£13.46
Y010040B2D	1/8" BSPT	0 – 6 bar / 0 – 100 psi	£13.46
Y016040B2D	1/8" BSPT	0 – 11 bar / 0 – 160 psi	£13.46
Y020040B2D	1/8" BSPT	0 – 14 bar / 0 – 200 psi	£13.46
Y030040B2D	1/8" BSPT	0 – 20 bar / 0 – 300 psi	£13.46

STEEL CASE, DRY GAUGES  
40 MM GAUGE DIAMETER

PART NUMBER	THREAD	MAX. PRESSURE SCALE	PRICE
Y001540A2D	1/8" BSPT	0 – 1 bar / 0 – 15 psi	£13.46
Y003040A2D	1/8" BSPT	0 – 2 bar / 0 – 30 psi	£13.46
Y006040A2D	1/8" BSPT	0 – 4 bar / 0 – 60 psi	£13.46
Y010040A2D	1/8" BSPT	0 – 6 bar / 0 – 100 psi	£13.46
Y016040A2D	1/8" BSPT	0 – 11 bar / 0 – 160 psi	£13.46
Y020040A2D	1/8" BSPT	0 – 14 bar / 0 – 200 psi	£13.46
Y030040A2D	1/8" BSPT	0 – 20 bar / 0 – 300 psi	£13.46

50 MM GAUGE DIAMETER

Y001550B2D	1/8" BSPT	0 – 1 bar / 0 – 15 psi	£16.19
Y003050B2D	1/8" BSPT	0 – 2 bar / 0 – 30 psi	£16.19
Y006050B2D	1/8" BSPT	0 – 4 bar / 0 – 60 psi	£16.19
Y010050B2D	1/8" BSPT	0 – 6 bar / 0 – 100 psi	£16.19
Y016050B2D	1/8" BSPT	0 – 11 bar / 0 – 160 psi	£16.19
Y020050B2D	1/8" BSPT	0 – 14 bar / 0 – 200 psi	£16.19
Y030050B2D	1/8" BSPT	0 – 20 bar / 0 – 300 psi	£16.19
Y001550B4D	1/4" BSPT	0 – 1 bar / 0 – 15 psi	£16.19
Y003050B4D	1/4" BSPT	0 – 2 bar / 0 – 30 psi	£16.19
Y006050B4D	1/4" BSPT	0 – 4 bar / 0 – 60 psi	£16.19
Y010050B4D	1/4" BSPT	0 – 6 bar / 0 – 100 psi	£16.19
Y016050B4D	1/4" BSPT	0 – 11 bar / 0 – 160 psi	£16.19
Y020050B4D	1/4" BSPT	0 – 14 bar / 0 – 200 psi	£16.19
Y030050B4D	1/4" BSPT	0 – 20 bar / 0 – 300 psi	£16.19

50 MM GAUGE DIAMETER

Y001550A2D	1/8" BSPT	0 – 1 bar / 0 – 15 psi	£16.19
Y003050A2D	1/8" BSPT	0 – 2 bar / 0 – 30 psi	£16.19
Y006050A2D	1/8" BSPT	0 – 4 bar / 0 – 60 psi	£16.19
Y010050A2D	1/8" BSPT	0 – 6 bar / 0 – 100 psi	£16.19
Y016050A2D	1/8" BSPT	0 – 11 bar / 0 – 160 psi	£16.19
Y020050A2D	1/8" BSPT	0 – 14 bar / 0 – 200 psi	£16.19
Y030050A2D	1/8" BSPT	0 – 20 bar / 0 – 300 psi	£16.19
Y001550A4D	1/4" BSPT	0 – 1 bar / 0 – 15 psi	£16.19
Y003050A4D	1/4" BSPT	0 – 2 bar / 0 – 30 psi	£16.19
Y006050A4D	1/4" BSPT	0 – 4 bar / 0 – 60 psi	£16.19
Y010050A4D	1/4" BSPT	0 – 6 bar / 0 – 100 psi	£16.19
Y016050A4D	1/4" BSPT	0 – 11 bar / 0 – 160 psi	£16.19
Y020050A4D	1/4" BSPT	0 – 14 bar / 0 – 200 psi	£16.19
Y030050A4D	1/4" BSPT	0 – 20 bar / 0 – 300 psi	£16.19

63 MM GAUGE DIAMETER

Y001563B4D	1/4" BSPT	0 – 1 bar / 0 – 15 psi	£18.06
Y003063B4D	1/4" BSPT	0 – 2 bar / 0 – 30 psi	£18.06
Y006063B4D	1/4" BSPT	0 – 4 bar / 0 – 60 psi	£18.06
Y010063B4D	1/4" BSPT	0 – 6 bar / 0 – 100 psi	£18.06
Y016063B4D	1/4" BSPT	0 – 11 bar / 0 – 160 psi	£18.06
Y020063B4D	1/4" BSPT	0 – 14 bar / 0 – 200 psi	£18.06
Y030063B4D	1/4" BSPT	0 – 20 bar / 0 – 300 psi	£18.06

63 MM GAUGE DIAMETER

Y001563A4D	1/4" BSPT	0 – 1 bar / 0 – 15 psi	£18.06
Y003063A4D	1/4" BSPT	0 – 2 bar / 0 – 30 psi	£18.06
Y006063A4D	1/4" BSPT	0 – 4 bar / 0 – 60 psi	£18.06
Y010063A4D	1/4" BSPT	0 – 6 bar / 0 – 100 psi	£18.06
Y016063A4D	1/4" BSPT	0 – 11 bar / 0 – 160 psi	£18.06
Y020063A4D	1/4" BSPT	0 – 14 bar / 0 – 200 psi	£18.06
Y030063A4D	1/4" BSPT	0 – 20 bar / 0 – 300 psi	£18.06

100 MM GAUGE DIAMETER

Y0015100B6D	3/8" BSPT	0 – 1 bar / 0 – 15 psi	£46.17
Y0030100B6D	3/8" BSPT	0 – 2 bar / 0 – 30 psi	£46.17
Y0060100B6D	3/8" BSPT	0 – 4 bar / 0 – 60 psi	£46.17
Y0100100B6D	3/8" BSPT	0 – 6 bar / 0 – 100 psi	£46.17
Y0160100B6D	3/8" BSPT	0 – 11 bar / 0 – 160 psi	£46.17
Y0200100B6D	3/8" BSPT	0 – 14 bar / 0 – 200 psi	£46.17
Y0300100B6D	3/8" BSPT	0 – 20 bar / 0 – 300 psi	£46.17

100 MM GAUGE DIAMETER

Y0015100A6D	3/8" BSPT	0 – 1 bar / 0 – 15 psi	£46.17
Y0030100A6D	3/8" BSPT	0 – 2 bar / 0 – 30 psi	£46.17
Y0060100A6D	3/8" BSPT	0 – 4 bar / 0 – 60 psi	£46.17
Y0100100A6D	3/8" BSPT	0 – 6 bar / 0 – 100 psi	£46.17
Y0160100A6D	3/8" BSPT	0 – 11 bar / 0 – 160 psi	£46.17
Y0200100A6D	3/8" BSPT	0 – 14 bar / 0 – 200 psi	£46.17
Y0300100A6D	3/8" BSPT	0 – 20 bar / 0 – 300 psi	£46.17

DRY PRESSURE GAUGES – DUAL SCALE

PANEL MOUNT GAUGES – CENTRE BACK CONNECTION



4600

STEEL CASE, DRY GAUGES  
40 MM GAUGE DIAMETER

PART NUMBER	THREAD	MAX. PRESSURE SCALE	PRICE
Y001540P2D	1/8" BSPT	0 – 1 bar / 0 – 15 psi	£22.40
Y003040P2D	1/8" BSPT	0 – 2 bar / 0 – 30 psi	£22.40
Y006040P2D	1/8" BSPT	0 – 4 bar / 0 – 60 psi	£22.40
Y010040P2D	1/8" BSPT	0 – 6 bar / 0 – 100 psi	£22.40
Y016040P2D	1/8" BSPT	0 – 11 bar / 0 – 160 psi	£22.40
Y020040P2D	1/8" BSPT	0 – 14 bar / 0 – 200 psi	£22.40
Y030040P2D	1/8" BSPT	0 – 20 bar / 0 – 300 psi	£22.40

Supplied with bracket



4600

STEEL CASE, DRY GAUGES  
50 MM GAUGE DIAMETER

PART NUMBER	THREAD	MAX. PRESSURE SCALE	PRICE
Y001550P4D	1/4" BSPT	0 – 1 bar / 0 – 15 psi	£25.13
Y003050P4D	1/4" BSPT	0 – 2 bar / 0 – 30 psi	£25.13
Y006050P4D	1/4" BSPT	0 – 4 bar / 0 – 60 psi	£25.13
Y010050P4D	1/4" BSPT	0 – 6 bar / 0 – 100 psi	£25.13
Y016050P4D	1/4" BSPT	0 – 11 bar / 0 – 160 psi	£25.13
Y020050P4D	1/4" BSPT	0 – 14 bar / 0 – 200 psi	£25.13
Y030050P4D	1/4" BSPT	0 – 20 bar / 0 – 300 psi	£25.13

Supplied with bracket

DRY VACUUM GAUGES

CENTRE BACK CONNECTION



4600

DRY VACUUM GAUGES  
40 MM GAUGE DIAMETER

PART NUMBER	THREAD	PRESSURE RANGE	PRICE
YV003040B2D	1/8" BSPT	-30" Hg / 0 – 1 bar	£13.46

50 MM GAUGE DIAMETER

YV003050B2D	1/8" BSPT	-30" Hg / 0 – 1 bar	£16.19
YV003050B4D	1/4" BSPT	-30" Hg / 0 – 1 bar	£16.19

BOTTOM CONNECTION



4600

DRY VACUUM GAUGES  
40 MM GAUGE DIAMETER

PART NUMBER	THREAD	PRESSURE RANGE	PRICE
YV003040A2D	1/8" BSPT	-30" Hg / 0 – 1 bar	£13.46

50 MM GAUGE DIAMETER

YV003050A2D	1/8" BSPT	-30" Hg / 0 – 1 bar	£16.19
YV003050A4D	1/4" BSPT	-30" Hg / 0 – 1 bar	£16.19

CENTRE BACK CONNECTION



4600

GLYCERINE FILLED GAUGES  
63 MM GAUGE DIAMETER

PART NUMBER	THREAD	MAX. PRESSURE SCALE	PRICE
Y001563B4G	1/4" BSPP	0 – 1 bar / 0 – 15 psi	£34.07
Y003063B4G	1/4" BSPP	0 – 2 bar / 0 – 30 psi	£34.07
Y006063B4G	1/4" BSPP	0 – 4 bar / 0 – 60 psi	£34.07
Y010063B4G	1/4" BSPP	0 – 6 bar / 0 – 100 psi	£34.07
Y020063B4G	1/4" BSPP	0 – 14 bar / 0 – 200 psi	£34.07
Y030063B4G	1/4" BSPP	0 – 20 bar / 0 – 300 psi	£34.07
Y040063B4G	1/4" BSPP	0 – 25 bar / 0 – 400 psi	£34.07
Y060063B4G	1/4" BSPP	0 – 40 bar / 0 – 600 psi	£34.07
Y0100063B4G	1/4" BSPP	0 – 60 bar / 0 – 1000 psi	£34.07
Y0200063B4G	1/4" BSPP	0 – 138 bar / 0 – 2000 psi	£34.07
Y0300063B4G	1/4" BSPP	0 – 200 bar / 0 – 3000 psi	£34.07
Y0400063B4G	1/4" BSPP	0 – 250 bar / 0 – 4000 psi	£34.07
Y0600063B4G	1/4" BSPP	0 – 400 bar / 0 – 6000 psi	£34.07

BOTTOM CONNECTION



4600

GLYCERINE FILLED GAUGES  
63 MM GAUGE DIAMETER

PART NUMBER	THREAD	MAX. PRESSURE SCALE	PRICE
Y001563A4G	1/4" BSPP	0 – 1 bar / 0 – 15 psi	£34.07
Y003063A4G	1/4" BSPP	0 – 2 bar / 0 – 30 psi	£34.07
Y006063A4G	1/4" BSPP	0 – 4 bar / 0 – 60 psi	£34.07
Y010063A4G	1/4" BSPP	0 – 6 bar / 0 – 100 psi	£34.07
Y020063A4G	1/4" BSPP	0 – 14 bar / 0 – 200 psi	£34.07
Y030063A4G	1/4" BSPP	0 – 20 bar / 0 – 300 psi	£34.07
Y040063A4G	1/4" BSPP	0 – 25 bar / 0 – 400 psi	£34.07
Y060063A4G	1/4" BSPP	0 – 40 bar / 0 – 600 psi	£34.07
Y0100063A4G	1/4" BSPP	0 – 60 bar / 0 – 1000 psi	£34.07
Y0200063A4G	1/4" BSPP	0 – 138 bar / 0 – 2000 psi	£34.07
Y0300063A4G	1/4" BSPP	0 – 200 bar / 0 – 3000 psi	£34.07
Y0400063A4G	1/4" BSPP	0 – 250 bar / 0 – 4000 psi	£34.07
Y0600063A4G	1/4" BSPP	0 – 400 bar / 0 – 6000 psi	£34.07

100 MM GAUGE DIAMETER

PART NUMBER	THREAD	MAX. PRESSURE SCALE	PRICE
Y0015100B8G	1/2" BSPP	0 – 1 bar / 0 – 15 psi	£83.65
Y0030100B8G	1/2" BSPP	0 – 2 bar / 0 – 30 psi	£83.65
Y0060100B8G	1/2" BSPP	0 – 4 bar / 0 – 60 psi	£83.65
Y0100100B8G	1/2" BSPP	0 – 6 bar / 0 – 100 psi	£83.65
Y0200100B8G	1/2" BSPP	0 – 14 bar / 0 – 200 psi	£83.65
Y0300100B8G	1/2" BSPP	0 – 20 bar / 0 – 300 psi	£83.65
Y0400100B8G	1/2" BSPP	0 – 25 bar / 0 – 400 psi	£83.65
Y0600100B8G	1/2" BSPP	0 – 40 bar / 0 – 600 psi	£83.65
Y01000100B8G	1/2" BSPP	0 – 60 bar / 0 – 1000 psi	£83.65
Y02000100B8G	1/2" BSPP	0 – 138 bar / 0 – 2000 psi	£83.65
Y03000100B8G	1/2" BSPP	0 – 200 bar / 0 – 3000 psi	£83.65
Y04000100B8G	1/2" BSPP	0 – 250 bar / 0 – 4000 psi	£83.65
Y06000100B8G	1/2" BSPP	0 – 400 bar / 0 – 6000 psi	£83.65

100 MM GAUGE DIAMETER

PART NUMBER	THREAD	MAX. PRESSURE SCALE	PRICE
Y0015100A8G	1/2" BSPP	0 – 1 bar / 0 – 15 psi	£83.65
Y0030100A8G	1/2" BSPP	0 – 2 bar / 0 – 30 psi	£83.65
Y0060100A8G	1/2" BSPP	0 – 4 bar / 0 – 60 psi	£83.65
Y0100100A8G	1/2" BSPP	0 – 6 bar / 0 – 100 psi	£83.65
Y0200100A8G	1/2" BSPP	0 – 14 bar / 0 – 200 psi	£83.65
Y0300100A8G	1/2" BSPP	0 – 20 bar / 0 – 300 psi	£83.65
Y0400100A8G	1/2" BSPP	0 – 25 bar / 0 – 400 psi	£83.65
Y0600100A8G	1/2" BSPP	0 – 40 bar / 0 – 600 psi	£83.65
Y01000100A8G	1/2" BSPP	0 – 60 bar / 0 – 1000 psi	£83.65
Y02000100A8G	1/2" BSPP	0 – 138 bar / 0 – 2000 psi	£83.65
Y03000100A8G	1/2" BSPP	0 – 200 bar / 0 – 3000 psi	£83.65
Y04000100A8G	1/2" BSPP	0 – 250 bar / 0 – 4000 psi	£83.65
Y06000100A8G	1/2" BSPP	0 – 400 bar / 0 – 6000 psi	£83.65

If calibration certificates are needed, please ask at time of ordering

Delivery times to be advised

ACCESSORIES



4600

GAUGE SNUBBER  
BRASS

PART NUMBER	THREAD	TYPE	PRICE
YOSNUB-04B	1/4" BSPP	Adjustable, piston type	£53.83
YOSNUB-08B	1/2" BSPP	Adjustable, piston type	£98.64



4600

GAUGE SNUBBER  
STAINLESS STEEL

PART NUMBER	THREAD	TYPE	PRICE
YOSNUB-04SS	1/4" BSPP	Adjustable, piston type	£98.64
YOSNUB-08SS	1/2" BSPP	Adjustable, piston type	£143.52

## FEATURES

- Glycerine filled for improved performance
- Bottom & panel mounted available
- Units measured in bar & psi
- Ø 100 & 150 mm manufactured in accordance with EN 837-1

## SPECIFICATIONS

Max. rec. working pressure	75% of full scale range
Protection	IP 65
Accuracy	Ø 63 mm ± 1.6% of full scale Ø 100 & 150 mm 0 – 1% of full scale
Temperature range	15°C to 65°C (59°F to 149°F)

## MATERIALS

Body	316 & 304 stainless steel
Dial face	Black & red graduations
Pointer	Aluminium
Gasket	Polychloroprene
Window	Plexiglass



## PANEL MOUNTING



**SERIES 940**  
**63 MM GAUGE DIAMETER**

170

PART NUMBER	THREAD	MAX. PRESSURE SCALE	PRICE
C199402320	1/2" BSPP	1000 bar / 14500 psi	£120.62
C199402321	1/4" NPT	1000 bar / 14500 psi	£120.62

## BOTTOM CONNECTION



**SERIES 940**  
**63 MM GAUGE DIAMETER**

170

PART NUMBER	THREAD	MAX. PRESSURE SCALE	PRICE
C199402120	1/2" BSPP	1000 bar / 14500 psi	£97.75
C199402121	1/4" NPT	1000 bar / 14500 psi	£97.75



**SERIES 940**  
**100 MM GAUGE DIAMETER**

170

PART NUMBER	THREAD	MAX. PRESSURE SCALE	PRICE
C199403320	1/2" BSPP	1000 bar / 14500 psi	£209.39
C199403321	1/2" BSPP	1600 bar / 23200 psi	£220.39
C199403322	1/2" BSPP	2000 bar / 29000 psi	£228.52



**SERIES 940**  
**100 MM GAUGE DIAMETER**

170

PART NUMBER	THREAD	MAX. PRESSURE SCALE	PRICE
C199403120	1/2" BSPP	1000 bar / 14500 psi	£197.25
C199403140	1/2" NPT	1000 bar / 14500 psi	£197.25
C199403121	1/2" BSPP	1600 bar / 23200 psi	£206.18
C199403122	1/2" BSPP	2000 bar / 29000 psi	£200.72



**SERIES 940**  
**150 MM GAUGE DIAMETER**

170

PART NUMBER	THREAD	MAX. PRESSURE SCALE	PRICE
C199404320	1/2" BSPP	1000 bar / 14500 psi	£272.77
C199404321	1/2" BSPP	1600 bar / 23200 psi	£272.77
C199404322	1/2" BSPP	2000 bar / 29000 psi	£272.77



**SERIES 940**  
**150 MM GAUGE DIAMETER**

170

PART NUMBER	THREAD	MAX. PRESSURE SCALE	PRICE
C199404120	1/2" BSPP	1000 bar / 14500 psi	£247.31
C199404121	1/2" BSPP	1600 bar / 23200 psi	£247.31
C199404122	1/2" BSPP	2000 bar / 29000 psi	£247.31

If calibration certificates are needed, please ask at time of ordering

Delivery times to be advised



## DESCRIPTION

For the measurement of fluid liquids that are not: highly viscous, high temperature (over 60°C), likely to solidify / crystallise or corrosive to copper or tin alloys.  
Also suitable for gases (except oxidising gases such as oxygen or acetylene) up to 25 bar maximum. Glycerine filled gauges are particularly suited to applications where oscillating / surging pressures or vibration are present. The damping effect of the glycerine will steady the pointer making it easier to take a reading against the scale.

## SPECIFICATIONS

Operating temperature range	Ambient: -20°C to +60°C Medium: 60°C maximum
Scales	Pressure: psi outer black & bar inner red Vacuum: HG outer black & bar inner red Compound: HG + psi outer black & bar inner red
Ingress protection	IP 65 as per EN 60529

## MATERIALS

Case & crimped bezel	304 stainless steel
Window	Polycarbonate – crystal clear
Pointer	Black aluminium
Dial	White aluminium
Filling	FDA approved food grade glycerine

## BOTTOM CONNECTION



8410

## GLYCERINE FILLED PRESSURE GAUGE 63 MM GAUGE DIAMETER

PART NUMBER	THREAD	PRESSURE SCALE	PRICE
HTP9801-60C	1/4" BSPP	Vacuum – 4 bar / -15 – 60 psi	£14.58
HTP9801-15	1/4" BSPP	0 – 1 bar / 0 – 15 psi	£14.58
HTP9801-30	1/4" BSPP	0 – 2 bar / 0 – 30 psi	£14.58
HTP9801-60	1/4" BSPP	0 – 4 bar / 0 – 60 psi	£14.58
HTP9801-100	1/4" BSPP	0 – 7 bar / 0 – 100 psi	£14.58
HTP9801-160	1/4" BSPP	0 – 11 bar / 0 – 160 psi	£14.58
HTP9801-200	1/4" BSPP	0 – 14 bar / 0 – 200 psi	£14.58
HTP9801-300	1/4" BSPP	0 – 20 bar / 0 – 300 psi	£14.58
HTP9801-400	1/4" BSPP	0 – 28 bar / 0 – 400 psi	£14.58
HTP9801-500	1/4" BSPP	0 – 35 bar / 0 – 500 psi	£14.58
HTP9801-600	1/4" BSPP	0 – 40 bar / 0 – 600 psi	£14.58
HTP9801-1000	1/4" BSPP	0 – 70 bar / 0 – 1000 psi	£14.58
HTP9801-1500	1/4" BSPP	0 – 100 bar / 0 – 1500 psi	£14.58
HTP9801-2000	1/4" BSPP	0 – 140 bar / 0 – 2000 psi	£14.58
HTP9801-2500	1/4" BSPP	0 – 170 bar / 0 – 2500 psi	£14.58
HTP9801-3000	1/4" BSPP	0 – 200 bar / 0 – 3000 psi	£14.58
HTP9801-4000	1/4" BSPP	0 – 280 bar / 0 – 4000 psi	£14.58
HTP9801-5000	1/4" BSPP	0 – 350 bar / 0 – 5000 psi	£14.58
HTP9801-6000	1/4" BSPP	0 – 400 bar / 0 – 6000 psi	£14.58
HTP9801-10000	1/4" BSPP	0 – 700 bar / 0 – 10000 psi	£20.49

## BACK CONNECTION



8410

## GLYCERINE FILLED PRESSURE GAUGE 63 MM GAUGE DIAMETER

PART NUMBER	THREAD	PRESSURE SCALE	PRICE
HTP9807-60C	1/4" BSPP	Vacuum – 4 bar / -15 – 60 psi	£19.06
HTP9807-15	1/4" BSPP	0 – 1 bar / 0 – 15 psi	£16.68
HTP9807-30	1/4" BSPP	0 – 2 bar / 0 – 30 psi	£16.68
HTP9807-60	1/4" BSPP	0 – 4 bar / 0 – 60 psi	£16.68
HTP9807-100	1/4" BSPP	0 – 7 bar / 0 – 100 psi	£16.68
HTP9807-160	1/4" BSPP	0 – 11 bar / 0 – 160 psi	£16.68
HTP9807-200	1/4" BSPP	0 – 14 bar / 0 – 200 psi	£16.68
HTP9807-300	1/4" BSPP	0 – 20 bar / 0 – 300 psi	£16.68
HTP9807-400	1/4" BSPP	0 – 28 bar / 0 – 400 psi	£16.68
HTP9807-500	1/4" BSPP	0 – 35 bar / 0 – 500 psi	£16.68
HTP9807-600	1/4" BSPP	0 – 40 bar / 0 – 600 psi	£16.68
HTP9807-1000	1/4" BSPP	0 – 70 bar / 0 – 1000 psi	£16.68
HTP9807-1500	1/4" BSPP	0 – 100 bar / 0 – 1500 psi	£16.68
HTP9807-2000	1/4" BSPP	0 – 140 bar / 0 – 2000 psi	£16.68
HTP9807-2500	1/4" BSPP	0 – 170 bar / 0 – 2500 psi	£16.68
HTP9807-3000	1/4" BSPP	0 – 200 bar / 0 – 3000 psi	£16.68
HTP9807-4000	1/4" BSPP	0 – 280 bar / 0 – 4000 psi	£16.68
HTP9807-5000	1/4" BSPP	0 – 350 bar / 0 – 5000 psi	£16.68
HTP9807-6000	1/4" BSPP	0 – 400 bar / 0 – 6000 psi	£16.68
HTP9807-10000	1/4" BSPP	0 – 700 bar / 0 – 10000 psi	£18.16

## 100 MM GAUGE DIAMETER

PART NUMBER	THREAD	PRESSURE SCALE	PRICE
HTP9803-60C	1/2" BSPP	Vacuum – 4 bar / -50 – 60 psi	£36.87
HTP9803-15	1/2" BSPP	0 – 1 bar / 0 – 15 psi	£36.88
HTP9803-30	1/2" BSPP	0 – 2 bar / 0 – 30 psi	£36.88
HTP9803-60	1/2" BSPP	0 – 4 bar / 0 – 60 psi	£36.88
HTP9803-100	1/2" BSPP	0 – 7 bar / 0 – 100 psi	£36.88
HTP9803-160	1/2" BSPP	0 – 11 bar / 0 – 160 psi	£36.88
HTP9803-200	1/2" BSPP	0 – 14 bar / 0 – 200 psi	£36.88
HTP9803-300	1/2" BSPP	0 – 20 bar / 0 – 300 psi	£36.88
HTP9803-400	1/2" BSPP	0 – 28 bar / 0 – 400 psi	£36.88
HTP9803-500	1/2" BSPP	0 – 35 bar / 0 – 500 psi	£36.88
HTP9803-600	1/2" BSPP	0 – 40 bar / 0 – 600 psi	£36.88
HTP9803-1000	1/2" BSPP	0 – 70 bar / 0 – 1000 psi	£36.88
HTP9803-1500	1/2" BSPP	0 – 100 bar / 0 – 1500 psi	£36.88
HTP9803-2000	1/2" BSPP	0 – 140 bar / 0 – 2000 psi	£36.88
HTP9803-2500	1/2" BSPP	0 – 170 bar / 0 – 2500 psi	£36.88
HTP9803-3000	1/2" BSPP	0 – 200 bar / 0 – 3000 psi	£36.88
HTP9803-4000	1/2" BSPP	0 – 280 bar / 0 – 4000 psi	£36.88
HTP9803-5000	1/2" BSPP	0 – 350 bar / 0 – 5000 psi	£36.88
HTP9803-6000	1/2" BSPP	0 – 400 bar / 0 – 6000 psi	£36.88
HTP9803-10000	1/2" BSPP	0 – 700 bar / 0 – 10000 psi	£36.88

## 100 MM GAUGE DIAMETER

PART NUMBER	THREAD	PRESSURE SCALE	PRICE
HTP9808-60C	1/2" BSPP	Vacuum – 4 bar / -50 – 60 psi	£49.84
HTP9808-15	1/2" BSPP	0 – 1 bar / 0 – 15 psi	£49.84
HTP9808-30	1/2" BSPP	0 – 2 bar / 0 – 30 psi	£49.84
HTP9808-60	1/2" BSPP	0 – 4 bar / 0 – 60 psi	£49.84
HTP9808-100	1/2" BSPP	0 – 7 bar / 0 – 100 psi	£49.84
HTP9808-160	1/2" BSPP	0 – 11 bar / 0 – 160 psi	£49.84
HTP9808-200	1/2" BSPP	0 – 14 bar / 0 – 200 psi	£49.84
HTP9808-300	1/2" BSPP	0 – 20 bar / 0 – 300 psi	£49.84
HTP9808-400	1/2" BSPP	0 – 28 bar / 0 – 400 psi	£49.84
HTP9808-500	1/2" BSPP	0 – 35 bar / 0 – 500 psi	£49.84
HTP9808-600	1/2" BSPP	0 – 40 bar / 0 – 600 psi	£49.84
HTP9808-1000	1/2" BSPP	0 – 70 bar / 0 – 1000 psi	£49.84
HTP9808-1500	1/2" BSPP	0 – 100 bar / 0 – 1500 psi	£49.84
HTP9808-2000	1/2" BSPP	0 – 140 bar / 0 – 2000 psi	£49.84
HTP9808-2500	1/2" BSPP	0 – 170 bar / 0 – 2500 psi	£49.84
HTP9808-3000	1/2" BSPP	0 – 200 bar / 0 – 3000 psi	£49.84
HTP9808-4000	1/2" BSPP	0 – 280 bar / 0 – 4000 psi	£49.84
HTP9808-5000	1/2" BSPP	0 – 350 bar / 0 – 5000 psi	£49.84
HTP9808-6000	1/2" BSPP	0 – 400 bar / 0 – 6000 psi	£49.84
HTP9808-10000	1/2" BSPP	0 – 700 bar / 0 – 10000 psi	£49.84



**DIGITAL PRESSURE GAUGES**
**DESCRIPTION**

HTE2 series digital pressure gauges are designed for both stationary & mobile measurement & display of pressure. They can be used as reference pressure gauges to simplify the checking, adjustment & calibration of other pressure measurement devices directly on site. Excellent protection against dust & moisture is provided by a membrane keypad with rubber buttons & rubber protective shroud.

**FEATURES**

- Accuracy  $\pm 0.5$  FS for exact & reliable measurement
- Ranges from -1 to 1000 bar
- 2 x 1.5 V DC standard AA battery supply
- Compact & rugged
- 320° rotatable display
- High operational readiness
- Easy & clear readout with backlight display
- IP67 protection for harsh environments
- Supplemental min / max peak capture

**SPECIFICATIONS**

Operating temperature range	0 to 50°C (32°F to 122°F)
Fluid temperature range	-20°C to +80°C
Storage temperature range	-20°C to +60°C

**MATERIALS**

Gauge	Stainless steel
Housing	Cast zinc with rubber protection cap
Integral flat gasket seal	NBR

**BOTTOM CONNECTION**

**DIGITAL PRESSURE GAUGE  
80 MM GAUGE DIAMETER**

8400

PART NUMBER	THREAD	PRESSURE SCALE	RESOLUTION	PRICE
HTPHTE2-0016	1/4" BSPP	Vacuum – 16 bar	1 mbar	£420.55
HTPHTE2-0060	1/4" BSPP	Vacuum – 60 bar	10 mbar	£420.55
HTPHTE2-0250	1/4" BSPP	0 – 250 bar	100 mbar	£420.55
HTPHTE2-0400	1/4" BSPP	0 – 400 bar	100 mbar	£420.55
HTPHTE2-0600	1/4" BSPP	0 – 600 bar	100 mbar	£420.55
HTPHTE2-1000	1/4" BSPP	0 – 1000 bar	100 mbar	£450.70

**PRESSURE GAUGE ACCESSORIES**
**GAUGE SNUBBER  
M3 RESTRICTOR SCREW**

8410

PART NUMBER	FOR USE WITH GAUGE TYPE	PRICE
HTPACC16000	63 mm bottom & back connection	£1.83

**M4 RESTRICTOR SCREW**

HTPACC16050	100 mm bottom & back connection	£2.57
-------------	---------------------------------	-------

**FRONT FIXING FLANGE  
3 HOLE**

8410

PART NUMBER	FOR USE WITH GAUGE TYPE	PRICE
HTP9807-FLANGE	63 mm back connection	£4.30
HTP9808-FLANGE	100 mm back connection	£10.49

**GAUGE SHROUD  
PROTECTIVE RUBBER COVER**

8410

PART NUMBER	FOR USE WITH GAUGE TYPE	PRICE
HTP9800-00-00.01	63 mm bottom connection	£6.19
HTP9803-CUFF	100 mm bottom connection	£29.06

**BRASS GAUGE THREAD ADAPTOR  
BSPP FEMALE / BSPP MALE**

8410

PART NUMBER	FEMALE THREAD	MALE THREAD	PRICE
HTP16GF-12GM	1/2" BSPP	3/8" BSPP	£22.43
HTP16GF-08GM	1/2" BSPP	1/4" BSPP	£22.43
HTP12GF-08GM	3/8" BSPP	1/4" BSPP	£22.43
HTP12GF-16GM	3/8" BSPP	1/2" BSPP	£22.43
HTP08GF-12GM	1/4" BSPP	3/8" BSPP	£22.43
HTP08GF-16GM	1/4" BSPP	1/2" BSPP	£22.43

**GAUGE CALIBRATION  
UKAS TRACEABLE CERTIFICATE**

8410

PART NUMBER	FOR USE WITH GAUGE TYPE	PRICE
HTP9801-CAL	63 mm bottom connection	£30.43
HTP9807-CAL	63 mm back connection	£30.43
HTP9803-CAL	100 mm bottom connection	£30.43
HTP9808-CAL	100 mm back connection	£30.43

**STEEL GAUGE THREAD ADAPTOR  
BSPP FEMALE /  
BSPP MALE WITH 60° CONE**

8410

PART NUMBER	FEMALE THREAD	MALE THREAD	PRICE
HTP2103-08-01.62	1/4" BSPP	1/4" BSPP	£9.60
HTP2103-08-02.62	1/2" BSPP	1/2" BSPP	£13.71

**REAR FIXING CLAMP**

8410

PART NUMBER	FOR USE WITH GAUGE TYPE	PRICE
HTP9807-CLAMP	63 mm back connection	£4.20
HTP9808-CLAMP	100 mm back connection	£8.46

## DATALOGGING DIGITAL PRESSURE GAUGES WITH MINI-USB CONNECTION

### DESCRIPTION

HTE2-L series digital pressure gauges are designed for both stationary & mobile measurement, display & datalogging of pressure. They can be used as reference pressure gauges to simplify the checking, adjustment & calibration of other pressure measurement devices directly on site. Excellent protection against dust & moisture is provided by a membrane keypad with rubber buttons & rubber protective shroud.

### FEATURES

- Mini-USB connection for download of recordings
- Data evaluation via Plug & Play – no additional drivers / software required
- Readout via Mini-USB to PC / laptop via USB cable – no converters required
- Storage of the measured values in CSV format – Processing in spreadsheets & database programmes
- Accuracy <0.5% FS
- Ranges from -1 to 1000 bar
- 27000 data records per test
- Space for 10 tests max 48h each
- Recording rate up 100ms
- 2 x 1.5V DC AA battery supply
- Back lit display with bar graph & min / max
- Compact & rugged IP67
- 270° rotatable display

### SPECIFICATIONS

Operating temperature range	0 to 50°C (32°F to 122°F)
Fluid temperature range	-20°C to +80°C
Storage temperature range	-20°C to +60°C

### MATERIALS

Gauge	Stainless steel
Housing	Cast zinc with rubber protection cap
Integral flat gasket seal	NBR



### BOTTOM CONNECTION

New

### DIGITAL PRESSURE GAUGE 80 MM GAUGE DIAMETER



8400

PART NUMBER	THREAD	PRESSURE SCALE	RESOLUTION	PRICE
HTPHTE2L-0016	1/4" BSPP	-1 – 16 bar	1 mbar	£778.20
HTPHTE2L-0060	1/4" BSPP	-1 – 60 bar	10 mbar	£778.20
HTPHTE2L-0250	1/4" BSPP	0 – 250 bar	100 mbar	£778.20
HTPHTE2L-0400	1/4" BSPP	0 – 400 bar	100 mbar	£778.20
HTPHTE2L-0700	1/4" BSPP	0 – 700 bar	100 mbar	£778.20
HTPHTE2L-1000	1/4" BSPP	0 – 1000 bar	100 mbar	£778.20

# Minimess® Monster

Are you a service engineer or maintenance professional looking for a reliable universal tool for pressure testing? Look no further than the Minimess® Monster Test Kit.

It is designed to cater to a wide range of mobile hydraulics machinery and manufacturers; this kit comes with a vast range of test point adaptors to Minimess® 1620 series connection, making it easy and safe to connect to almost any test point variant.

Whether you need to create a connection into hydraulic lines or test tees, this kit covers you. It includes an extensive range of male / swivel female test tees with Minimess® 1620 test points fitted to suit BSP, metric, JIC and ORFS hose and pipework. All tees have blanking caps and plugs to seal off the lines if required.

### Applications

- Agricultural
- Construction
- Off road
- Heavy plant
- Lifting & platforms



Available on request

Please contact your distributor for further information



## DIGITAL PRESSURE GAUGE KITS

### FEATURES

- Test under pressure using leak-free Minimess connections up to 630 bar
- Connect & disconnect under full system pressure
- Finger tight connection
- Ranges from -1 to 1000 bar
- Min & max data capture
- Back lit display
- 2 x 1.5 V DC AA battery supply
- Compact & rugged IP67
- 320° rotatable display

### KIT CONTENTS

- 1 or 2 x HTE2 series digital pressure gauges with 1620 male connection, user selectable up to 1000 bar
- 2 x SNA series Minimess male / swivel female 1620 inline test point adaptors – 3/8" & 1/2" BSPP
- 2 x Minimess 1620 test points – G1/4" BSPP & M10x1 male thread
- 1 x G1/4" BSPP gauge female to Minimess 1620 female gauge adaptor
- 1 x 630 bar rated Minimess microbore pressure test hose – 1.5 m
- Additional 3/8" & 1/2" BSPP male threaded adaptors & seals

Other gauge combinations available  
please ask your distributor for details



8400

### MINIMESS® DIGITAL GAUGE KITS C/W 1.5 M HOSE & TEST POINTS

PART NUMBER	THREAD	PRESSURE SCALE	RESOLUTION	PRICE
HTP3101-81-01.50	1/4" BSPP	-1 – 16 bar	1 mbar	£592.57
HTP3101-81-04.50	1/4" BSPP	-1 – 60 bar	10 mbar	£592.57
HTP3101-81-07.50	1/4" BSPP	0 – 250 bar	100 mbar	£592.57
HTP3101-81-08.50	1/4" BSPP	0 – 400 bar	100 mbar	£592.57
HTP3101-81-09.50	1/4" BSPP	0 – 600 bar	100 mbar	£592.57
HTP3101-81-0A.50	1/4" BSPP	0 – 1000 bar	100 mbar	£592.57

## UNIVERSAL PRESSURE TEST KITS

### FEATURES

- All major test point variants covered with one kit. The ultimate service tool
- Connect & disconnect under full system pressure. Lifetime leak free guarantee
- In-line test point tees offer excellent system access versatility
- Amazing value for range of testing capabilities included
- Printed logo & contact details on kit box (minimum order of 5 kits)

### KIT CONTENTS

- 2 x 63 mm glycerine filled pressure gauges user selectable up to 700 bar
- 3 x Minimess male / swivel female 1620 inline test point adaptors. 1/4", 3/8" & 1/2" BSPP
- 4 x Minimess 1620 changeover adaptors from 1215, 1615, HSP (5/8"BSF) & F/F quick release
- 1 x Minimess 1620 test point – 1/4" BSPP male threaded
- 1 x G1/4" BSPP to 1620 gauge adaptor
- 2 x 630 bar rated Minimess pressure test hoses (1620 & Steck) – 1.5 m
- Additional 3/8" & 1/2" BSPP male threaded adaptors & seals

Other gauge combinations available  
please ask your distributor for details



8410

### MINIMESS® UNIVERSAL PRESSURE TEST KITS

PART NUMBER	PRESSURE SCALE		PRICE
	GAUGE 1	GAUGE 2	
HTP3101-16-38.UTK	0 – 40 bar	0 – 400 bar	£373.22



## ECONOMY PRESSURE TEST KITS

### FEATURES

- Test under pressure using Hydrotechnik leak free Minimess connections up to 630 bar
- Everything you need to get two pressure readings
- Ultra low cost – ideal for OEMs
- Lifetime leak free guarantee
- Printed logo & contact details on kit box (minimum order of 5 kits)

### KIT CONTENTS

- 2 x 63 mm glycerine filled pressure gauges user selectable up to 700 bar
- 2 x Minimess 1620 test points – 1/4" BSPP & M10x1 threaded
- 1 x G1/4" BSPP to 1620 gauge adaptor
- 1 x 630 bar rated Minimess pressure test hose – 1.5 m long
- Additional 3/8" & 1/2" BSPP male threaded adaptors & seals

Other gauge combinations available  
please ask your distributor for details



8410

### MINIMESS® ECONOMY PRESSURE TEST KITS

PART NUMBER	PRESSURE SCALE		PRICE
	GAUGE 1	GAUGE 2	
HTP3101-16-38.LC	0 – 40 bar	0 – 400 bar	£142.69

## BSPP PRESSURE TEST KITS

### FEATURES

- Test under pressure using Hydrotechnik leak free Minimess connections up to 630 bar
- Connect & disconnect under full system pressure. Lifetime leak free guarantee
- In-line test point tees offer excellent system access versatility
- Still our most popular & best value kit
- Printed logo & contact details on kit box (minimum order of 5 kits)

### KIT CONTENTS

- 2 x 63 mm glycerine filled pressure gauges user selectable up to 700 bar
- 3 x Minimess male / swivel female 1620 inline test point adaptors. 1/4", 3/8" & 1/2" BSPP
- 1 x Minimess 1620 test point – 1/4" BSPP
- 1 x G1/4" BSPP to 1620 gauge adaptor
- 1 x 630 bar rated Minimess pressure test hose – 1.5 m long
- Additional 3/8" & 1/2" BSPP male threaded adaptors & seals

Other gauge combinations available  
please ask your distributor for details



8410

### MINIMESS® BSPP PRESSURE TEST KITS

PART NUMBER	PRESSURE SCALE		PRICE
	GAUGE 1	GAUGE 2	
HTP3101-16-38.50	0 – 40 bar	0 – 400 bar	£188.34

## MINIMESS® 1620 TEST POINTS & ADAPTORS

### DESCRIPTION

Minimess 1620 or 'Test 20' is the most commonly used test point across all industries. The wide range of choice in materials & threads make this the most versatile range available

### SPECIFICATIONS

Working temperature range	NBR: -25°C to +100°C FKM: -20°C to +200°C
Max. working pressure	630 bar

**Thread form data**

**Form C**

Thread port according to DIN 3852 part 1 and part 2, form 2 (sealed with suitable sealant)

G	h	t
ISO 7 x 1 - BSPP	5.5	9.8
ISO 7 x 1 - BSPP	8.5	13.5

**Form E**

Thread port according to SAE J 514 (UNF) or according to ISO 6149-1 (sealed with O-ring)

SAE J 514 (UNF)

G	d <sub>1</sub>	d <sub>2</sub>	b	k	l	h	z"
7/16-20 UNF	21.0	12.4	11.5	2.4	14.0	1.6	12.0
1/2-20 UNF	29.0	14.0	11.5	2.4	14.0	1.6	12.0
9/16-18 UNF	35.0	15.0	12.7	2.5	15.5	1.6	12.0
3/4-16 UNF	40.0	20.0	14.3	2.5	17.5	2.4	12.0

ISO 6149-1

G	d <sub>1</sub>	d <sub>2</sub>	b	k	l	h	z"
M10 x 1	19.0	11.1	10.0	1.8	11.5	1.0	12.0
M12 x 1.5	19.0	13.0	11.5	2.4	14.0	1.8	15.0
M14 x 1.5	21.0	15.0	11.5	2.4	14.0	1.8	15.0
M16 x 1.5	24.0	17.8	13.0	2.4	15.5	1.8	15.0

**Form F**

Thread Port up to Ø d according to DIN 3852 part 1 and part 2, from X (sealed with flat seal)

G	d	w	b	t
ISO 229-6-1/8	15.0	1.0	6.0	13.0
ISO 229-6-1/4	30.0	1.5	12.0	18.5
ISO 229-6-3/8	35.0	2.0	13.0	19.0
ISO 229-6-1/2	37.5	2.5	14.0	22.0
M12 x 1.5	16.0	1.5	12.0	13.5
M14 x 1.5	18.0	1.8	12.0	16.5
M16 x 1.5	22.0	1.8	13.0	18.5

**Form G**

Thread Port according to HYDROTECHNIK standard N901-01-14 (sealed with O-ring)

G	d	b	t
M8 x 1	8.5	8.0	13.0
M10 x 1	11.5	8.0	13.0

**Form H**

Thread Port according to ANSI/ASME B 1.20.1-1983 (self sealing thread)

G	t
1/8 NPTF	12.0
1/4 NPTF	17.5
1/2 NPTF	22.0

### MINIMESS 1620 TEST POINT STEEL WITH NBR SEALS METRIC MALE



8430

PART NUMBER	THREAD	SEAL TYPE	PRICE
HTP2103-01-33.00	M10 x 1.0	Form G	£28.97
HTP2103-01-13.00	M12 x 1.5	Form F	£34.03
HTP2103-01-14.00	M14 x 1.5	Form F	£22.46
HTP2103-01-15.00	M16 x 1.6	Form F	£34.03

### BSPP MALE

HTP2103-01-17.00	1/8" BSPP	Form F	£12.21
HTP2103-01-18.00	1/4" BSPP	Form F	£12.21
HTP2103-01-51.CN	1/4" BSPP	Cone	£30.87
HTP2103-01-16.00	3/8" BSPP	Form F	£22.45

### NPTF MALE

HTP2103-01-46.00	1/8" NPTF	Form H	£22.46
HTP2103-01-47.00	1/4" NPTF	Form H	£22.46

### UNF MALE

HTP2103-01-21.00	7/16" UNF	Form E	£22.45
HTP2103-01-53.00	9/16" UNF	Form E	£22.45

### BSPT MALE

HTP2103-01-40.00	1/8" BSPT	Form C	£29.36
HTP2103-01-41.00	1/4" BSPT	Form C	£28.97

### MINIMESS 1620 TEST POINT STAINLESS STEEL WITH FKM SEALS BSPP MALE



8430

PART NUMBER	THREAD	SEAL TYPE	PRICE
HTP2703-01-17.10	1/8" BSPP	Form F	£87.46
HTP2703-01-18.10	1/4" BSPP	Form F	£87.46

### NPTF MALE

HTP2703-01-47.10	1/4" NPTF	Form H	£101.11
------------------	-----------	--------	---------

Other threads available on request

## MINIMESS® 1620 TEST POINT ADAPTORS CW FITTED TEST POINT



**INLINE TEE – LIGHT SERIES**  
METRIC DKO MALE /  
SWIVEL FEMALE

8430

PART NUMBER	TUBE OD	THREAD	PRICE
HTP2103-KL-06.00	6 mm	M12 x 1.5	£73.03
HTP2103-KL-08.00	8 mm	M14 x 1.5	£72.03
HTP2103-KL-10.00	10 mm	M16 x 1.5	£66.52
HTP2103-KL-12.00	12 mm	M18 x 1.5	£77.41
HTP2103-KL-15.00	15 mm	M22 x 1.5	£72.52
HTP2103-KL-18.00	18 mm	M26 x 1.5	£91.23
HTP2103-KL-22.00	22 mm	M30 x 2.0	£102.20



**INLINE TEE**  
BSPP MALE /  
BSPP SWIVEL FEMALE 60° CONE

8430

PART NUMBER	THREAD	PRICE
HTPSNA01	1/4" BSPP	£28.09
HTPSNA02	3/8" BSPP	£28.66
HTPSNA03	1/2" BSPP	£29.87
HTPSNA04	3/4" BSPP	£34.22
HTPSNA05	5/8" BSPP	£32.82
HTPSNA06	1" BSPP	£45.10
HTPSNA07	1 1/4" BSPP	£72.23
HTPSNA08	1 1/2" BSPP	£102.42



**INLINE TEE – HEAVY SERIES**  
METRIC DKO MALE / SWIVEL FEMALE

8430

PART NUMBER	TUBE OD	THREAD	PRICE
HTP2103-KS-06.00	6 mm	M14 x 1.5	£66.52
HTP2103-KS-08.00	8 mm	M16 x 1.5	£71.98
HTP2103-KS-10.00	10 mm	M18 x 1.5	£78.54
HTP2103-KS-12.00	12 mm	M20 x 1.5	£69.75
HTP2103-KS-16.00	16 mm	M24 x 1.5	£77.21
HTP2103-KS-20.00	20 mm	M30 x 2.0	£101.95



**INLINE TEE**  
JIC MALE /  
JIC SWIVEL FEMALE 37° CONE

8430

PART NUMBER	THREAD	PRICE
HTPSNA55	7/16" JIC	£29.99
HTPSNA56	1/2" JIC	£31.08
HTPSNA57	9/16" JIC	£32.06
HTPSNA58	3/4" JIC	£33.05
HTPSNA59	7/8" JIC	£34.03
HTPSNA60	1 1/16" JIC	£43.39
HTPSNA61	1 5/16" JIC	£52.15
HTPSNA62	1 5/8" JIC	£68.26
HTPSNA63	1 7/8" JIC	£100.07



**INLINE STANDPIPE – LIGHT SERIES**  
METRIC DKO FEMALE  
24° SEALING CONE

8430

PART NUMBER	TUBE OD	THREAD	PRICE
HTP2103-93-06.00	6 mm	M12 x 1.5	£27.53
HTP2103-93-08.00	8 mm	M14 x 1.5	£33.08
HTP2103-93-10.00	10 mm	M16 x 1.5	£34.92
HTP2103-93-12.00	12 mm	M18 x 1.5	£39.88
HTP2103-93-15.00	15 mm	M22 x 1.5	£33.93
HTP2103-40-18.00	18 mm	M26 x 1.5	£32.83
HTP2103-40-22.00	22 mm	M30 x 2.0	£51.93
HTP2103-40-28.00	28 mm	M36 x 2.0	£70.22
HTP2103-40-35.00	35 mm	M45 x 2.0	£67.74



**INLINE TEE**  
ORFS MALE / ORFS SWIVEL FEMALE

8430

PART NUMBER	THREAD	PRICE
HTPSNA70	9/16" ORFS	£34.76
HTPSNA71	11/16" ORFS	£36.14
HTPSNA72	13/16" ORFS	£39.02
HTPSNA73	1" ORFS	£40.29
HTPSNA74	1 3/16" ORFS	£44.20
HTPSNA75	1 7/16" ORFS	£46.96



**INLINE STANDPIPE – HEAVY SERIES**  
METRIC DKO FEMALE  
24° SEALING CONE

8430

PART NUMBER	TUBE OD	THREAD	PRICE
HTP2103-94-06.00	M14 x 1.5	6 mm	£35.19
HTP2103-94-08.00	M16 x 1.5	8 mm	£34.76
HTP2103-94-10.00	M18 x 1.5	10 mm	£46.45
HTP2103-94-12.00	M20 x 1.5	12 mm	£46.20
HTP2103-94-14.00	M22 x 1.5	14 mm	£38.18
HTP2103-94-16.00	M24 x 1.5	16 mm	£45.16
HTP2103-41-20.00	M30 x 2.0	20 mm	£48.52
HTP2103-41-25.00	M36 x 2.0	25 mm	£53.63
HTP2103-41-30.00	M42 x 2.0	30 mm	£75.07

## MINIMESS® 1620 TEST POINT ADAPTORS

### GAUGE ADAPTOR FEMALE TEST POINT TO GAUGE FEMALE



8430

PART NUMBER	THREAD	THREAD	PRICE
HTP2103-07-11.62	M16 x 2	1/4" BSPP	£26.33
HTP2103-07-12.62	M16 x 2	1/2" BSPP	£34.62
HTP2103-07-23.62	M16 x 2	1/4" NPT	£37.98

### HOSE ADAPTOR WITHOUT VALVE MALE TEST POINT THREAD



8430

PART NUMBER	THREAD	PRICE
HTP2146-01-00.00	M16 x 2	£28.07

### BULKHEAD ADAPTOR WITH VALVE MALE TEST POINT THREADS



8430

PART NUMBER	THREAD	PRICE
HTP2103-04-16.00	M16 x 2	£51.83

### TEST POINT CONVERSION ADAPTOR WITHOUT VALVE MALE / FEMALE TEST POINT THREADS



8430

PART NUMBER	MALE THREAD	FEMALE THREAD	PRICE
HTP2101-07-44.62	M16 x 2.0	M12 x 1.5	£65.68
HTP2102-07-44.62	M16 x 2.0	M16 x 1.5	£63.42
HTPHSPF/1620M	5/8" BSF (HSP)	M16 x 2.0	£37.11

### BULKHEAD ADAPTOR WITHOUT VALVE MALE TEST POINT / FEMALE GAUGE



8430

PART NUMBER	THREAD	PRICE
HTP2103-05-11.00	1/4" BSPP	£25.18
HTP2103-05-12.00	1/2" BSPP	£31.42
HTP2103-05-23.00	1/4" NPT	£39.35

### PRESSURE & TEMPERATURE TEST POINT WITH VALVE MALE THREAD – NBR SEALS



8430

PART NUMBER	THREAD	SEALING FORM	PRICE
HTP2149-04-15.13	1/4" BSPP	Form F	£81.31
HTP2149-04-19.13	M10 x 1.0	Form G	£76.62

## MICROBORE HOSE ASSEMBLIES

### DESCRIPTION

The microbore hose is available in 2 mm internal diameter up to 400 bar working pressure. The hose material is extremely flexible, lightweight & can be specified for a large range of uses.

### APPLICATIONS

- Oils
- Water
- Bleeding
- Gases
- Sampling
- Aggressive media
- Grease
- Permanent installations
- Pressure testing up to 630 bar

### SPECIFICATIONS

Min. bend radius	20 (below -20°C 30mm)
Working temperature range	-20°C up to +100°C (-4°F to +212°F) short time up to 120°C (248°F)

Pressure loss curve of DN 2 hose only  
Pressure loss in Bar per metre of hose length  
without fittings, mineral oil: viscosity 30mm<sup>2</sup> s<sup>-1</sup>

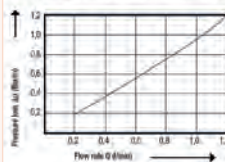

Pressure loss curve of DN 2 hose assemblies  
Pressure loss in Bar through a hose assembly with a length  
of 1 m, with fittings and Test Points of series 1620 on both  
sides, mineral oil: viscosity 30mm<sup>2</sup> s<sup>-1</sup>

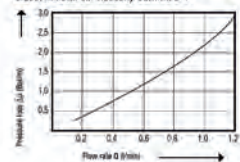

**Safety note:** The hose assemblies have to be protected from flames and sharp-edged, hot objects.

### DN2 HOSE ASSEMBLY 1620 FEMALE / 1620 FEMALE



8430

PART NUMBER					PRICE per assy.
HTPS110-AC-AC-00.20	2	0.2	M16 x 2	630	£38.69
HTPS110-AC-AC-00.40	2	0.4	M16 x 2	630	£39.65
HTPS110-AC-AC-00.80	2	0.8	M16 x 2	630	£45.45
HTPS110-AC-AC-01.00	2	1.0	M16 x 2	630	£43.29
HTPS110-AC-AC-01.50	2	1.5	M16 x 2	630	£49.81
HTPS110-AC-AC-02.00	2	2.0	M16 x 2	630	£49.36
HTPS110-AC-AC-03.00	2	3.0	M16 x 2	630	£54.56
HTPS110-AC-AC-04.00	2	4.0	M16 x 2	630	£59.37
HTPS110-AC-AC-05.00	2	5.0	M16 x 2	630	£65.55

### DN2 HOSE ASSEMBLY 1620 FEMALE / BSPP SWIVEL GAUGE FEMALE



8430

PART NUMBER					PRICE per assy.
HTPS110-AC-FA-00.20	2	0.2	1/4	630	£38.69
HTPS110-AC-FA-00.40	2	0.4	1/4	630	£39.65
HTPS110-AC-FA-00.80	2	0.8	1/4	630	£42.06
HTPS110-AC-FA-01.00	2	1.0	1/4	630	£43.29
HTPS110-AC-FA-01.50	2	1.5	1/4	630	£46.13
HTPS110-AC-FA-02.00	2	2.0	1/4	630	£49.36
HTPS110-AC-FA-03.00	2	3.0	1/4	630	£54.56
HTPS110-AC-FA-04.00	2	4.0	1/4	630	£59.37
HTPS110-AC-FA-05.00	2	5.0	1/4	630	£65.55

MINIMESS® GAS CHARGING VALVES

FEATURES

- Compatible with inert gases, nitrogen & compressed air
- Resistant against antifreeze, oil, anti-corrosion oil, grease & fuel
- Internal primary & secondary sealing as well as integral seat seal & anti-vibration O-ring (to prevent loosening of the metal cap) made of FKM
- Gas charging valve must be rinsed & cleaned before using oxygen

SPECIFICATIONS

Working temperature range	-20°C to +135°C (-4°F to +275°F)
Max. working pressure	630 bar



MINIMESS 1615 GAS CHARGING VALVE  
MALE

8400

PART NUMBER	THREAD	SEALING FORM	PRICE
HTP2402-01-18.00	1/4" BSPP	Form F	£86.42
HTP2402-01-26.00	1/2" UNF	Form F	£71.33

ACCUMULATOR GAS CHARGING & TESTING KITS

DESCRIPTION

Accumulator charging & testing kit used for charging bladder, diaphragm & piston accumulators with nitrogen as well as pressure checking & pressure adjustment.

FEATURES

- Safe & easy to use Minimess charging & testing connections
- Connects to most types of bladder accumulator valve
- Minimess test points offer excellent system access versatility
- Simple hand tightening hose connection on to charging valves
- Low cost solution for charging of different accumulator valves
- Safely test, charge or bleed
- Test or charge using Hydrotechnik Minimess connections up to 630 bar
- Simple hand tightening hose connection on to accumulator charging device
- Compact accumulator charging device
- Connection options for most popular bladder accumulator charging valves
- Economically priced

FEATURES

- Safe & easy to use Minimess charging & testing connections
- Safely test, charge or bleed
- Connects to most types of bladder, diaphragm & piston accumulator valves
- Minimess test points offer excellent system access versatility
- Simple hand tightening hose connection on to charging valves
- Low cost solution for testing & charging of a wide range of accumulators
- Test or charge using Hydrotechnik Minimess connections up to 630 bar
- Simple hand tightening hose connection on to accumulator charging device
- Connection options for most popular accumulator charging valves
- Economically priced

KIT CONTENTS

- Valve body complete with 5/8" – 18 UNF female ring nut connection to accumulator gas valve, with bleed & Minimess charging hose connection
- Accumulator charging valve adaptors to 7/8" – 14 UNF female, (short thread), 5/16" – 32 UNEF (VG8) female (short thread) & 1/4" BSP female (with pin)
- 2.5 m long high pressure microbore flexible hose complete with Minimess connections
- Two pressure gauges (60 bar & 250 bar)
- 5/8" BSP male bullnose adaptor to connect to nitrogen bottle with Minimess charging hose connection
- Set of spare gaskets
- Carrying case

KIT CONTENTS

- Valve body complete with M28x1.5 female ring nut connection to accumulator gas valve, with bleed & Minimess charging hose connection
- Accumulator charging valve adaptors to 7/8" – 14 UNF female, (short & long thread), 5/16" – 32 UNEF (VG8) female (short & long thread) & 1/4" BSP female (with pin)
- 2.5 m long high pressure Minimess microbore flexible charging hose
- Two pressure gauges (60 bar & 250 bar)
- 5/8" BSP male bullnose adaptor to connect to nitrogen bottle with Minimess charging hose connection
- Set of spare gaskets
- Carrying case



8400

ACCUMULATOR GAS CHARGING & TESTING KIT  
COMPACT KIT



8400

ACCUMULATOR GAS CHARGING & TESTING KIT  
UNIVERSAL KIT

PART NUMBER	DESCRIPTION	PRICE
HTPPC280/70-D	Accumulator charging & testing kit typically used for charging bladder accumulators with nitrogen as well as pressure checking & pressure adjustment.	£538.97

PART NUMBER	DESCRIPTION	PRICE
HTPPCFPU280/70-U	Gas charging kit for bladder, diaphragm or piston accumulators with nitrogen or to check or reduce existing precharge pressure in accumulators.	£901.28



# Flow Products

Flow products are essential components used in various light industrial applications. They play a critical role in helping engineers detect abnormal flows through local displays or output signals.

Flow meters are used in a variety of industrial applications, such as:

- Verifying liquid and gas flow rates: Original Equipment Manufacturers (OEMs) integrate liquid and gas flow meters to ensure accurate flow rates in their equipment.
- Quality Control: A tubing manufacturer supplies custom tube assemblies to a bottling and canning equipment manufacturer. To ensure quality, technicians perform a flow test on the tube assemblies to check for leaks and blockages.
- Fuel consumption monitoring: Engineers use flow meters to measure shallow flows of petrol / diesel or fuel cells and determine the fuel and water combination.

## Available Ranges

- Spinner type indicators
- Rising ball indicators
- Diaphragm pressure switches
- Piston pressure switches
- Temperature pressure switches
- Vacuum switches





### FEATURES

- Low cost, entry level, sight flow indicators
- High sensitivity spinner or ball types available
- Compact design
- Operates from 0.7 l/m (water)
- NBR seals & nylon spinner or PTFE ball give excellent chemical resistance

Size	Flowrate (l/h water)	
	Minimum	Maximum
1/4"	30	200
3/8"	50	450
1/2"	60	600
3/4"	120	1600
1"	300	1600

### SPECIFICATIONS

	GUNMETAL	STAINLESS STEEL
Max. temperature	100°C (212°F)	100°C (212°F)
Max. pressure	7 bar	16 bar
<b>MATERIALS</b>		
Body	Gunmetal BS EN1982CB491K	Stainless steel ASTM A351 CF8M
Glass	Soda lime glass BS3463	Toughened borosilicate DIN7080
Cover ring	Brass – BS2872 CZ122	
Gasket	NBR O-ring – BS128	
Spinner mounting pin	Stainless steel – 316	
Spinner	Nylon	
Ball	PTFE	

### SPINNER TYPE INDICATORS



1905

**SIGHT FLOW INDICATORS**  
GUNMETAL  
BSPT FEMALE

PART NUMBER	THREAD	LENGTH	PRICE
FIG-1703001	1/4" BSPT	76 mm	£214.08
FIG-1703051	3/8" BSPT	76 mm	£214.08
FIG-1703101	1/2" BSPT	76 mm	£214.08
FIG-1703151	3/4" BSPT	83 mm	£253.18
FIG-1703201	1" BSPT	89 mm	£373.71

### RISING BALL INDICATORS



1905

**SIGHT FLOW INDICATORS**  
GUNMETAL  
BSPT FEMALE

PART NUMBER	THREAD	LENGTH	PRICE
FIG-1766001	1/4" BSPT	76 mm	£242.40
FIG-1766051	3/8" BSPT	76 mm	£270.87
FIG-1766101	1/2" BSPT	76 mm	£270.87
FIG-1766151	3/4" BSPT	83 mm	£279.20
FIG-1766201	1" BSPT	89 mm	£407.69

### Do you also need?



### Air preparation products



Find it on pages 303 – 310, section five

### Do you also need?



### Cylinders & accessories



Find it on pages 342 – 353, section six

SPECIFICATIONS	
Connection	1/8" BSPT
Voltage	250 V AC
Max. fluid temperature	80°C to 120°C depending on diaphragm
Action type	1B
Protection degree	IP65
Operating temperature	Diaphragm type: -10°C to +120°C Piston type: -15°C to +100°C
Max. overpressure limit	Diaphragm type: 300 bar Piston type: 800 bar
Max. working pressure limit	Diaphragm type: 150 bar Piston type: 450 bar
MATERIALS	
Case	Anodised aluminium
Electrical contacts	Zinc plated steel
Seal	Diaphragm type: FKM Piston type: NBR



**PRESSURE SWITCH WITH SPDT CONTACTS DIAPHRAGM TYPE**

5940

PART NUMBER	SETTING RANGE	TOLERANCE AT 20°C	PRICE
SPVL2400121	0.3 – 5 bar	± 0.15 bar	£116.87
SPVL2400122	1 – 10 bar	± 0.5 bar	£116.87
SPVL2400123	10 – 25 bar	± 1 bar	£116.87
SPVL2400124	25 – 80 bar	± 2.5 bar	£116.87

**PISTON TYPE**

SPVL2400115	50 – 200 bar	± 2 ÷ 10 bar	£127.53
SPVL2400116	100 – 400 bar	± 3 ÷ 15 bar	£127.53

## DIAPHRAGM PRESSURE SWITCHES

SPECIFICATIONS	
Connection	1/4" BSPP
Voltage	48 V
Max. fluid temperature	80°C to 120°C depending on diaphragm
Action type	1B
Protection degree	IP 00
Operating temperature	-10°C to +120°C
Max. overpressure limit	300 bar
Max. working pressure	150 bar
MATERIALS	
Case	Zinc plated steel
Electrical contacts	Silver AgNi
Seal	FKM

SPECIFICATIONS	
Connection	1/4" BSPP
Voltage	250 V AC
Max. fluid temperature	80°C to 120°C depending on diaphragm
Action type	1B
Protection degree	IP65
Operating temperature	-10°C to +120°C
Max. overpressure limit	300 bar
Max. working pressure	150 bar
MATERIALS	
Case	Zinc plated steel
Electrical contacts	Silver
Seal	FKM



5940

**DIAPHRAGM PRESSURE SWITCH ≤ 48 V NORMALLY OPEN**

PART NUMBER	SETTING RANGE	TOLERANCE AT 20°C	PRICE
SPVL4110620	0.1 – 1 bar	± 0.1 bar	£38.43
SPVL411062A	0.2 – 2 bar	± 0.15 bar	£38.43
SPVL4110621	1 – 5 bar	± 0.3 bar	£38.43
SPVL4110622	1 – 10 bar	± 0.5 bar	£38.43
SPVL4110623	10 – 20 bar	± 1.0 bar	£38.43
SPVL4110624	20 – 50 bar	± 2.0 bar	£38.43

**≤ 48 V NORMALLY CLOSED**

SPVL4120620	0.1 – 1 bar	± 0.1 bar	£38.43
SPVL412062A	0.2 – 2 bar	± 0.15 bar	£38.43
SPVL4120621	1 – 5 bar	± 0.3 bar	£38.43
SPVL4120622	1 – 10 bar	± 0.5 bar	£38.43
SPVL4120623	10 – 20 bar	± 1.0 bar	£38.43
SPVL4120624	20 – 50 bar	± 2.0 bar	£38.43



5940

**DIAPHRAGM PRESSURE SWITCH WITH SPDT CONTACTS**

PART NUMBER	SETTING RANGE	TOLERANCE AT 20°C	PRICE
SPVL4920H20	0.3 – 1.5 bar	± 0.15 bar	£71.64
SPVL4920H21	1 – 5 bar	± 0.3 bar	£71.64
SPVL4920H22	1 – 12 bar	± 0.5 bar	£71.64
SPVL4920H23	10 – 60 bar	± 2 bar	£71.64

PISTON PRESSURE SWITCHES

**SPECIFICATIONS**

Connection	1/4" BSPP
Max. switched voltage	48 V
Electrical condition	NO (red) NC (blue)
Max. switched current	0.5 A
Max. fluid temperature	100°C
Action type	1B
Protection degree	IP 00
Max. overpressure limit	800 bar
Max. working pressure	450 bar

**MATERIALS**

Case	Zinc plated steel
Electrical contacts	Silver AgNi
Seal	NBR



5940

**PISTON PRESSURE SWITCH  
≤ 48 V NORMALLY OPEN**

PART NUMBER	SETTING RANGE	TOLERANCE AT 20°C	PRICE
SPVL4010H16	50 – 150 bar	± 2 ÷ 10 bar	£63.25
SPVL4010H17	100 – 300 bar	± 5 ÷ 15 bar	£63.25

**≤ 48 V NORMALLY CLOSED**

SPVL4020H16	50 – 150 bar	± 2 ÷ 10 bar	£63.25
SPVL4020H17	100 – 300 bar	± 5 ÷ 15 bar	£63.25

**SPECIFICATIONS**

Connection	1/4" BSPP
Voltage	250 V AC
Max. fluid temperature	100°C
Electrical condition	SPDT (exchange contact)
Action type	1B
Tightening torque max	50 Nm
Protection degree	IP65
Max. overpressure limit	900 bar
Max. working pressure	450 bar

**MATERIALS**

Case	Zinc plated steel
Electrical contacts	Silver
Seal	NBR



5940

**PISTON PRESSURE SWITCH  
WITH SPDT CONTACTS**

PART NUMBER	SETTING RANGE	TOLERANCE AT 20°C	PRICE
SPVL4820H16	50 – 200 bar	± 2 ÷ 10 m bar	£82.98
SPVL4820H17	200 – 400 bar	± 4 ÷ 15 m bar	£82.98

**SPECIFICATIONS**

Connection	1/4" BSPF
Voltage	250 V AC
Max. fluid temperature	100°C
Action type	IB
Protection degree	IP65
Max. overpressure limit	900 bar
Tolerance	± 2%

**MATERIALS**

Case	Anodised aluminium
Electrical contacts	SPDT silver
Seal	NBR & Teflon



5940

**PISTON PRESSURE SWITCH  
WITH ADJUSTING KNOB**

PART NUMBER	SETTING RANGE	PRICE
SPVL69223015	8 – 150 bar	£198.61
SPVL69223016	40 – 400 bar	£198.61

TEMPERATURE SWITCHES

**SPECIFICATIONS**

Differential	15/20 K
Intervention tolerance	+/- 5 K
Max. ambient temperature	85°C
Number of cycles	100.000 (max. 5 per minute)
Max. tightening torque	40 Nm
Protection degree	IP65 / ATEX
Max. pressure	80 bar

**MATERIALS**

Case	Brass
------	-------



5940

**BIMETALLIC THERMOSTAT  
TEMPERATURE SWITCH  
WITH SPDT CONTACTS**

PART NUMBER	THREAD	TEMPERATURE	PRICE
SPVL5072102050	3/8" BSPP	50°C	£71.51
SPVL5072102060	3/8" BSPP	60°C	£71.51
SPVL5072102070	3/8" BSPP	70°C	£71.51
SPVL5072102080	3/8" BSPP	80°C	£71.51
SPVL5072108050	1/2" BSPP	50°C	£71.51
SPVL5072108060	1/2" BSPP	60°C	£71.51
SPVL5072108070	1/2" BSPP	70°C	£71.51
SPVL5072108080	1/2" BSPP	80°C	£71.51

## VACUUM SWITCHES

### SPECIFICATIONS

Thread	1/4" BSPT
Max. switched voltage	48 V
Setting range	-200 / -900 m bar
Tolerance at 20°C	± 100
Max. switched current	0.5 A
Max. fluid temperature	80°C to 120°C
Action type	1B
Max. overpressure limit	15 bar
Max. working pressure	10 bar

### MATERIALS

Case	Brass
Electrical contacts	Silver AgNi



5940

### VACUUM SWITCH

PART NUMBER	DESCRIPTION	PRICE
SPVL3511219	Normally open	£43.97
SPVL3521219	Normally closed	£43.97

### SPECIFICATIONS

Thread	1/4" BSPT
Voltage	240 V
Max. fluid temperature	80°C to 120°C depending on diaphragm
Action type	1B
Protection degree	IP65
Max. tightening torque	25 Nm
Max. overpressure limit	15 bar
Max. working pressure	10 bar

### MATERIALS

Case	Brass
Electrical contacts	Silver



5940

### DIAPHRAGM VACUUM SWITCH WITH SPDT CONTACTS NORMALLY OPEN

PART NUMBER	SETTING RANGE	TOLERANCE AT 20°C	PRICE
SPVL3821229	-200 / -900 m bar	± 100 m bar	£87.45

## LEVEL SWITCHES

### SPECIFICATIONS

Temperature range (atm. pressure)	-10°C to +80°C
Pressure resistance (room temperature)	0.2 MPa
Specific gravity of the liquid	Heavier than 0.8

### MATERIALS

Stem	PP
Float	PP foamed
Stopper	SUS304 (PP)
Nat	PP

### ELECTRIC SPECIFICATIONS

Max. contact capacity	50 W DC / AC
Max. voltage	300 V DC / AC
Max. current	0.5 A DC / AC



5940

### SIDE ENTRY LEVEL SWITCH EXTERNAL FITTING

PART NUMBER	THREAD	PRICE
SPVLMFS10N1	1/2" BSPT	£29.97



5940

### POLYPROPYLENE TOP ENTRY LEVEL SWITCH WITH 25 MM FLOAT

PART NUMBER	THREAD	PRICE
SPVLMFS17C	1/8" BSPP	£16.56

## FLOAT VALVES

### FEATURES

- Connection with gas thread cylindrical DIN – ISO 228/1985
- Guarantees a perfect seal with minimum force from the float
- Maximum variable pressure 10 bar
- Nominal pressure PN-10
- Patented valve system
- Swing type valve
- Valve closes progressively



5940

### FLOAT VALVE 304 STAINLESS STEEL

PART NUMBER	THREAD	PRICE
SPVL11-00110-B1	3/8"	£91.63
SPVL11-00115-B1	1/2"	£96.81
SPVL11-00120-B1	3/4"	£136.18
SPVL11-00125-B1	1"	£161.39
SPVL11-00132-B1	1 1/4"	£176.81

# An Eco-Friendly Vacuum System



Companies can reduce their carbon footprint and costs by using minimal energy. Piab can help achieve this.

## Environmental Index

When placed closer to the suction point, your pump will require less compressed air, reducing CO<sub>2</sub> emissions and energy consumption.

The graph illustrates how the environmental impact varies with the distance of the pump from the point of suction.

It is advisable to use a decentralised vacuum system. Such a system has the vacuum pump or cartridge placed directly at the suction point, eliminating the risk of loss in the vacuum piping and the need for expensive, oversized components.

- Lowest energy usage
- Fastest cycle time
- Safest product handling
- Most flexible design for zoning
- Easiest troubleshooting
- Independently working suction cups
- Most consistent / even performance



In contrast, a centralised vacuum system is designed to have one vacuum source for multiple suction points.









- Easy installation
- Easy vacuum sensing and controls
- Light end-of-arm tooling
- Simple filtration options
- Some loss in system performance due to distance

Contact your distributor for further information



## SUCTION CUPS / GRIPPERS INTRODUCTION

SUCTION CUP CATEGORY	FEATURES	APPLICATIONS
 <p>piGRIP® Modular suction cups</p>	<ul style="list-style-type: none"> <li>• Unique modular suction cup concept with individually optimised lips &amp; bellows for gripping, lifting &amp; height compensation on almost any kind of object.</li> <li>• A large selection of fittings makes piGRIP cups ready to fit new machines &amp; easy to retrofit.</li> <li>• The material is 100% recyclable.</li> <li>• Available in FDA approved qualities: silicone (PWIS) free &amp; mark free versions.</li> <li>• The combination of firm bellows &amp; soft lips will allow for high machine speeds.</li> <li>• There is also a fitting that has an ejector integrated, the COAX® in piGRIP for creating a decentralised pump.</li> </ul>	<p>Smooth, textured, uneven &amp; also very rough surfaces on objects such as plastic pieces, wood, sheet metal (dry), glass, corrugated cardboard, carton, food, tiles, etc.</p>
 <p>DURAFLEX® Single durometer</p>	<ul style="list-style-type: none"> <li>• Manufactured in a material that features the elasticity of rubber &amp; wear resistance of polyurethane.</li> <li>• The material is silicone free &amp; mark free.</li> <li>• Has an exceptional elastic memory.</li> <li>• The single durometer DURAFLEX cups are extra wear resistant &amp; long lasting.</li> </ul>	<p>Smooth surfaces on objects such as plastic pieces, furniture parts, sheet metal (dry), glass, solar panels, etc.</p>
 <p>DURAFLEX® Dual durometer</p>	<ul style="list-style-type: none"> <li>• Manufactured in a material that features the elasticity of rubber &amp; wear resistance of polyurethane.</li> <li>• The material is silicone free &amp; mark free.</li> <li>• Has an exceptional elastic memory.</li> <li>• The dual durometer DURAFLEX cups have firm bellows or body &amp; a soft pliable lip.</li> <li>• The suction cup is then stable, durable &amp; flexible with excellent sealing properties.</li> </ul>	<p>Textured, uneven &amp; also very rough surfaces on objects such as plastic pieces, wood, sheet metal (dry), glass, corrugated cardboard, carton, tiles, etc.</p>

SUCTION CUP CATEGORY	FEATURES	APPLICATIONS
 <p><b>DURAFLEX® Friction</b></p>	<ul style="list-style-type: none"> <li>• Manufactured in a material that features the elasticity of rubber &amp; wear resistance of polyurethane.</li> <li>• The material is silicone free &amp; mark free.</li> <li>• Has an exceptional elastic memory.</li> <li>• Has an exceptional grip / shear force of oily surfaces.</li> <li>• Wear on the cups will not degrade the shear / grip performance; it will improve.</li> <li>• These cups are outstanding for handling oily metal sheets with high speed acceleration.</li> </ul>	Oily metal sheets & other lubricated surfaces.
 <p><b>DURAFLEX® Bag</b></p>	<ul style="list-style-type: none"> <li>• Manufactured in a material that features the elasticity of rubber &amp; wear resistance of polyurethane.</li> <li>• The material is silicone free &amp; mark free.</li> <li>• Has an exceptional elastic memory.</li> <li>• Specially designed for plastic bag handling.</li> <li>• The unique suction cup fitting allows the high initial flow needed for a secure grip.</li> <li>• The dual hardness suction cup with soft lip &amp; firm bellows offers better sealing capabilities.</li> <li>• Stable &amp; secure handling.</li> </ul>	Plastic bag handling.
 <p><b>FDA</b></p>	<ul style="list-style-type: none"> <li>• The material is free from colour pigments.</li> <li>• The silicone material complies with FDA (FDA 21 CFR 177.2600).</li> <li>• Meets EU's regulation EU 1935/2004.</li> <li>• Wide temperature range.</li> <li>• Available from very small sizes.</li> </ul>	Contact with food or FDA environments.
 <p><b>Silicone</b></p>	<ul style="list-style-type: none"> <li>• Durable silicone material.</li> <li>• Soft &amp; pliable.</li> <li>• Possible to get a good grip on non-smooth surfaces.</li> <li>• Wide temperature range.</li> <li>• Available from very small sizes.</li> <li>• Options with detectable silicone material &amp; conductive / antistatic silicone.</li> </ul>	Packages, pre-coloured plastic parts (high temperature), bakery (detectable), electronics / semiconductor (conductive / antistatic).
 <p><b>Silicone Bag</b></p>	<ul style="list-style-type: none"> <li>• Durable silicone material.</li> <li>• Soft &amp; pliable.</li> <li>• Tailor-made for handling different types of bags &amp; pouches with varying content.</li> <li>• The design is optimised for uneven, wrinkled bags &amp; pouches.</li> <li>• It will minimise the 'surface leakage' &amp; maximise the grip.</li> <li>• The unique fitting allows the high initial flow needed for a secure grip.</li> </ul>	Bags with fragile contents & food, bags with liquids, viscous contents & frozen food, 'easy' bags, open bags.
 <p><b>NBR-PVC &amp; CR</b></p>	<ul style="list-style-type: none"> <li>• Oil, petrol &amp; ozone resistant material.</li> <li>• Larger sizes are made of NBR-PVC &amp; smaller sizes of CR (chloroprene).</li> </ul>	Conventional suction cups material for general purposes.
 <p><b>TPU</b></p>	<ul style="list-style-type: none"> <li>• Probably the most mark-free suction cups on the market! (Almost all suction cups will leave detectable marks or traces on a 'micro' level, some washable, others not. Tests have proven that these TPU cups are the best option when marks are not allowed.)</li> </ul>	Solar panels, glass, displays, screens.
 <p><b>HNBR</b></p>	<ul style="list-style-type: none"> <li>• High temperature applications where silicone or other paint-wetting impairment substances (PWIS) are not allowed.</li> <li>• Made of HNBR.</li> <li>• Very durable &amp; wear resistant.</li> </ul>	Removing hot plastic parts from injection moulding equipment, glass handling.

## MX RANGE

### DESCRIPTION

Outstanding for picking different objects – Primarily for logistics, warehousing, e-commerce, & recycling applications. A multi-purpose suction cup with extreme gripping capabilities on any surface. Comes in sizes 35 – 65 mm in diameter. Very good for handling difficult bags, pouches, cardboard boxes, recycled objects, & much more.

A Trippel durometer cup design: soft thin lip giving exceptional vacuum sealing capabilities. Sturdy but easy folding bellows for great holding force in dynamic grips. Firm neck for safe & sturdy interface towards a variety of fitting options including aluminum clamp fittings. The suction cup is made of Duraflex® a material that features the elasticity of rubber & wear resistance of polyurethane. The material has a fantastic elastic memory & 'mark free' capabilities. This gives a suction cup with high longevity even with the thin lip. This new suction cup family is compatible with all piGRIP® fittings & their features. Low vacuum flow design – exceptional sealing capabilities at lower vacuum levels. Forgiving for handling different types of objects, less vacuum flow needed, even on difficult objects.

Energy saving – the exceptional vacuum sealing performance gives less need of high vacuum flows with a significant reduction of compressed air usage. Approx. diameter can vary depending on the surfaces to which the cup is applied to.

### FEATURES

- For logistics, warehousing, e-commerce, & recycling applications
- Outstanding for picking different objects
- A multi-purpose suction cup with extreme gripping capabilities on any surface
- Very good for handling difficult bags, pouches, cardboard boxes & recycled objects
- The cup is made of Duraflex® a material that features the elasticity of rubber & wear resistance of polyurethane
- The material has a fantastic elastic memory & 'mark free' capabilities
- Configure the cup by using Piab's suction cup configurator

### FITTING GUIDE

G – G thread	18 – 1/8"
GC – G thread clamp ring	14 – 1/4"
GL – G thread low	38 – 3/8"
M – M thread	12 – 1/2"
NS – NPSF thread	M5 – 5 mm
NT – NPT thread	M6 – 6 mm
NLT – NPT thread low	M8 – 8 mm
P – Push-on (max 70.0 N)	M10 – 10 mm
MR – Male replacement for NS518F	M12 – 12 mm
FM – Filter mesh	D08 – 8 mm
FF – Female thread	D10 – 10 mm
	D11 – 11 mm



**SUCTION CUP  
CUP ONLY**

5020

PART NUMBER	MODEL	FITTING	PRICE
VAC-9956829	MX35	-	£34.82

### CUP WITH FITTING

VAC-9956573	MX35	G18M	£38.21
VAC-9956641	MX35	G18M-FM	£38.67
VAC-9957297	MX35	G18F	£38.21
VAC-9958023	MX35	G18F-FM	£38.67
VAC-9958956	MX35	G18MR	£38.21
VAC-9959021	MX35	GC18M	£54.72
VAC-9959770	MX35	GC18M-FM	£55.18
VAC-9958359	MX35	GL18M	£38.21
VAC-9956576	MX35	G14M	£38.21
VAC-9956666	MX35	G14M-FM	£38.67
VAC-9957697	MX35	G14F	£38.21
VAC-9960177	MX35	G14F-FM	£38.67
VAC-9958250	MX35	GC14M	£54.72
VAC-9959024	MX35	GC14M-FM	£55.18
VAC-9959011	MX35	GL14M	£38.21
VAC-9956568	MX35	G38M	£38.21
VAC-9956754	MX35	G38M-FM	£38.67
VAC-9957071	MX35	G38F	£38.21
VAC-9957559	MX35	G38F-FM	£38.67
VAC-9957663	MX35	G12M	£38.21



**SUCTION CUP  
CUP ONLY**

5020

PART NUMBER	MODEL	FITTING	PRICE
VAC-9958602	MX42	-	£41.27

### CUP WITH FITTING

VAC-9958538	MX42	G18M	£44.65
VAC-9959019	MX42	G18M-FM	£45.11
VAC-9959049	MX42	G18F	£44.65
VAC-9958699	MX42	G18F-FM	£45.11
VAC-9958574	MX42	G14M	£44.65
VAC-9959340	MX42	G14M-FM	£45.11
VAC-9959172	MX42	G14F	£44.65
VAC-9959412	MX42	GC14M	£60.83
VAC-9959225	MX42	GC14M-FM	£61.29
VAC-9959569	MX42	GL14M	£44.65
VAC-9958539	MX42	G38M	£44.65
VAC-9958530	MX42	G38M-FM	£45.11
VAC-9958601	MX42	G38F-FM	£45.11
VAC-9958578	MX42	GC38M	£60.83
VAC-9958831	MX42	G12M	£44.65

MX RANGE – CONTINUED



SUCTION CUP  
CUP ONLY

5020

PART NUMBER	MODEL	FITTING	PRICE
VAC-9956830	MX50	-	£47.71

CUP WITH FITTING

VAC-9956580	MX50	G18M	£51.10
VAC-9956578	MX50	G18M-FM	£51.56
VAC-9959050	MX50	G18F	£51.10
VAC-9956574	MX50	G14M	£51.10
VAC-9957539	MX50	G14M-FM	£51.56
VAC-9957805	MX50	G14F	£51.10
VAC-9956569	MX50	G38M	£51.10
VAC-9956755	MX50	G38M-FM	£51.56
VAC-9956994	MX50	G38F	£51.10
VAC-9957560	MX50	G38F-FM	£51.56
VAC-9956602	MX50	G12M	£51.10
VAC-9960424	MX50	G12F	£51.10
VAC-9958251	MX50	GC14M	£66.94
VAC-9958249	MX50	GC38M	£66.94
VAC-9957437	MX50	GL14M	£51.10



SUCTION CUP  
CUP ONLY

5020

PART NUMBER	MODEL	FITTING	PRICE
VAC-9956949	MX65	-	£60.60

CUP WITH FITTING

VAC-9956581	MX65	G18M	£63.99
VAC-9959052	MX65	G18F	£63.99
VAC-9959045	MX65	G18F-FM	£64.45
VAC-9956699	MX65	G14M	£63.99
VAC-9957779	MX65	G14M-FM	£64.45
VAC-9958042	MX65	G14F	£63.99
VAC-9958252	MX65	GC14M	£89.78
VAC-9956570	MX65	G38M	£63.99
VAC-9956756	MX65	G38M-FM	£64.45
VAC-9956637	MX65	G38F	£63.99
VAC-9957561	MX65	G38F-FM	£64.45
VAC-9958811	MX65	GC38M	£89.78
VAC-9956582	MX65	G12M	£63.99
VAC-9959639	MX65	G12M-FM	£64.45
VAC-9956638	MX65	G12F	£63.99



SUCTION CUP  
CUP ONLY

5020

PART NUMBER	MODEL	FITTING	PRICE
VAC-9958778	MX57	-	£54.16

CUP WITH FITTING

VAC-9958583	MX57	G18M	£57.54
VAC-9959695	MX57	G18M-FM	£58.01
VAC-9959051	MX57	G18F	£57.54
VAC-9958767	MX57	G14M	£57.54
VAC-9959694	MX57	G14M-FM	£58.01
VAC-9959173	MX57	G14F	£57.54
VAC-9958832	MX57	G12M	£57.54
VAC-9960423	MX57	G12F	£57.54
VAC-9958541	MX57	G38M	£57.54
VAC-9958531	MX57	G38M-FM	£58.01
VAC-9960011	MX57	G38F	£57.54
VAC-9958579	MX57	GC38M	£83.92

Do you also need?



PAF flat suction cups

Piab Automotive Flat, design suitable for slightly domed & flat surfaces, e.g., such as those encountered when handling metal sheets in automotive body shop applications. Designed to handle both dry & oily workpieces & can withstand high shear forces. The PAF suction cups have support cleats that prevent thin objects from being disfigured.



Available on request, please contact your distributor for further information.





# PIAB Configurable Suction Cups

## Grip any product!

If you are looking for a suction cup that can grip any product, PIAB's piGRIP® might be the solution. This unique suction cup concept offers individually optimised parts for gripping, lifting, and height compensation.

## Fitting and flow restrictors

With a wide range of fittings, you can easily retrofit existing suction cups or fit new machines. The fittings are available in both threaded and push-on options. In addition, piGRIP® cups come with flow restrictors that allow you to handle different sizes of objects in a centralised vacuum system.

## Bellows

You can also choose from various bellows, including firm and stable 1, 3 and 6 folded bellows, which enable faster machine speeds. The tin wall design makes them compress faster, using less force and energy. Compared to similar conventional cups, the strength of the material increases the lifting capacity between 30% and 50%. You can also choose transparent, FDA-approved material.

## Filters

Furthermore, the low-micron filter disc inside the bellows traps dust and particles, which increases system reliability. A mesh filter is available in the fitting as well.

## Lips

The suction cups also come with a variety of lips that are tailored to your needs. From standard 60° shore lips to highly flexible, soft lips on 30° shore, PIAB has got you covered. They even offer tailor-made bag lips for handling bags and pouches, foam lips for objects that are difficult to grip with traditional cups, and high-temperature lips for specific applications.



Contact your distributor for further information

piGRIP®



60°-67° TPE, CE resistant, Silver/PAES free & Mark free  
 90°-92° TPE, FDA, CE resistant, Silver/PAES free & Mark free

Standard: TPE, CE resistant, Silver/PAES free & Mark free  
 Flexible: 30° TPE, FDA; 50° TPE, FDA  
 Bag Lip: Silver, FDA  
 Hot Surface Lip: 150° High temperature of material, up to 150°C/PAES free & Mark free

Foam: PU EPDM, Foam; PU NR, Foam



New

# PIAB Bag & Pouch Opening

Piab's innovative suction cups and ejectors provide a reliable vacuum solution with minimum interference and maintenance.

Piab also offers intelligent vacuum ejectors that improve energy efficiency and provide process monitoring capabilities.

Piab's range of bag cups includes cups designed for bag opening, allowing for gripping, opening and keeping bags open while filling.

There are two types of bag-opening cups, the F26 and F33. Both cups are flat and have cleats designed to optimise their performance when opening bags and handling thin sheets. These cups have a thin and conformable lip, as well as a clever cleat pattern that helps prevent sensitive bags from getting sucked in and damaged and provides enhanced lifting force.

Developed in partnership with a leading form-fill-seal machine manufacturer, the F26 and F33 cups are made of silicone and comply with both FDA and EU standards for use with food.

Contact your distributor for further information



Energy Efficient

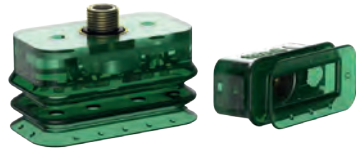

U RANGE

U FEATURES

- Universal suction cup
- Suitable for objects with flat or slightly curved surfaces
- Also used for concave objects
- Suction cups of conductive silicone are suitable for objects with sensitivity to static electricity



UNIVERSAL SUCTION CUP  
CHLOROPRENE

5020

PART NUMBER	MODEL	THREAD	PRICE
VAC-3150059	U4	M5 male	£4.00
VAC-3150003	U6	M5 male	£4.24
VAC-3150004	U8	M5 male	£4.41
VAC-3150005	U10	M5 male	£4.82
VAC-3150006	U15	M5 male	£5.30
VAC-0101373	U20	M5 female	£12.39

CHLOROPRENE WITH MESH FILTER

VAC-0101374	U20	1/8" BSPP male	£12.76
-------------	-----	----------------	--------

SILICONE

VAC-3150059S	U4	M5 male	£5.71
VAC-3150003S	U6	M5 male	£6.13
VAC-3150004S	U8	M5 male	£6.42
VAC-3150005S	U10	M5 male	£7.01
VAC-3150006S	U15	M5 male	£7.85
VAC-0117947	U15-3	M5 male	£7.78

SILICONE WITH MESH FILTER

PART NUMBER	MODEL	THREAD	PRICE
VAC-0101385	U20	1/8" BSPP male	£15.66
VAC-0101395	U30	M5 female	£16.74
VAC-0101396	U30	1/8" BSPP male	£17.11
VAC-0101610	U40-2	1/8" NPSF female	£22.11
VAC-0101605	U40-2	1/4" BSPP male	£22.11
VAC-0101810	U50-2	1/8" NPSF female	£26.36
VAC-0101805	U50-2	1/4" BSPP male	£26.36

SILICONE WITH DUAL FLOW CONTROL VALVE

VAC-0101390	U20	M5 female	£25.22
-------------	-----	-----------	--------

CONDUCTIVE SILICONE

PART NUMBER	MODEL	THREAD	PRICE
VAC-3250080SC	U2	M2.5 male	£11.41
VAC-3250081SC	U3	M2.5 male	£11.48

HNBR

VAC-9906863	U10	M5 male	£5.81
VAC-9906864	U15	M5 male	£6.09
VAC-9906867	U20	M5 female	£12.70

HNBR WITH MESH FILTER

VAC-9906869	U20	1/8" BSPP male	£13.07
-------------	-----	----------------	--------

NBR-PVC

VAC-0101406	U30	M5 female	£13.68
-------------	-----	-----------	--------

NBR-PVC WITH MESH FILTER

VAC-0101407	U30	1/8" BSPP male	£14.05
VAC-0101623	U40-2	1/8" NPSF female	£18.38
VAC-0101618	U40-2	1/4" BSPP male	£18.38
VAC-0101823	U50-2	1/8" NPSF female	£22.00
VAC-0101818	U50-2	1/4" BSPP male	£22.00

F RANGE

F FEATURES

- Flat suction cup with cleats
- Suitable for flat objects
- Good stability & little inherent movement
- Recommended when the lifting force is parallel to the surface of the object
- Cleats prevent thin, sensitive objects from being deformed & gives extra friction when the lifting force is parallel



FLAT SUCTION CUP WITH CLEATS

CHLOROPRENE

5020

PART NUMBER	MODEL	THREAD	PRICE
VAC-3150014	F15	M5 male	£5.49
VAC-0101259	F20	M5 female	£12.65
VAC-0101260	F20	1/8" BSPP male	£13.02
VAC-0101292	F25	M5 female	£13.31
VAC-0101293	F25	1/8" BSPP male	£13.68
VAC-0101325	F30-2	M5 female	£13.97
VAC-0101326	F30-2	1/8" BSPP male	£14.34

SILICONE

PART NUMBER	MODEL	THREAD	PRICE
VAC-3150014S	F15	M5 male	£8.08
VAC-0101270	F20	M5 female	£15.76
VAC-0101271	F20	1/8" BSPP male	£16.13
VAC-0101303	F25	M5 female	£16.65
VAC-0101304	F25	1/8" BSPP male	£17.02
VAC-0101341	F30-2	M5 female	£17.22
VAC-0101342	F30-2	1/8" BSPP male	£17.59

HNBR WITH MESH FILTER

PART NUMBER	MODEL	THREAD	PRICE
VAC-0108181	F50-2	1/8" NPSF female	£39.96
VAC-0108182	F50-2	1/4" BSPP male	£40.86
VAC-0108183	F50-2	3/8" BSPP male	£40.86
VAC-0108184	F75	1/8" NPSF female	£88.81
VAC-0108185	F75	3/8" BSPP female	£88.81
VAC-0108188	F110	3/8" BSPP female	£136.11
VAC-0108190	F110	1/2" BSPP female	£136.11

NBR versions available on request

Mesh filter versions available on request

**B RANGE**

**B FEATURES**

- Suction cup with short bellows
- Lifting movement to separate small & thin objects
- Only lightweight objects should be handled when the lifting force is parallel to the surface
- Suitable for level adjustment



**SUCTION CUP WITH SHORT BELLOWS  
CHLOROPRENE**

5020

PART NUMBER	MODEL	THREAD	PRICE
VAC-3250082	B5	M5 male	£4.07
VAC-3250083	B8	M5 male	£4.49
VAC-3150023	B10-2	M5 male	£4.98
VAC-3250037	B15-2	M5 male	£5.70
VAC-0101160	B20	M5 female	£13.34

**CHLOROPRENE WITH MESH FILTER**

VAC-0101161	B20	1/8" BSPP male	£13.71
VAC-0101423	B30-2	1/8" NPSF female	£18.26
VAC-0101418	B30-2	1/4" BSPP male	£18.26
VAC-0101420	B30-2	3/8" BSPP male	£18.26
VAC-0101462	B40	1/8" NPSF female	£20.85
VAC-0101457	B40	1/4" BSPP male	£20.85
VAC-0101459	B40	3/8" BSPP male	£20.85
VAC-0101649	B50	1/8" NPSF female	£25.48
VAC-0101644	B50	1/4" BSPP male	£25.48
VAC-0101646	B50	3/8" BSPP male	£25.48
VAC-0101854	B75	1/8" NPSF female	£57.81
VAC-0101855	B75	3/8" BSPP female	£57.81
VAC-0101857	B75	1/2" BSPP female	£57.81

**SILICONE**

PART NUMBER	MODEL	THREAD	PRICE
VAC-3250082S	B5	M5 male	£7.48
VAC-3250083S	B8	M5 male	£8.28
VAC-3150023S	B10-2	M5 male	£9.42
VAC-3250037S	B15-2	M5 male	£10.31
VAC-0101171	B20	M5 female	£18.93

**SILICONE WITH MESH FILTER**

VAC-0101172	B20	1/8" BSPP male	£19.30
VAC-0101436	B30-2	1/8" NPSF female	£25.07
VAC-0101431	B30-2	1/4" BSPP male	£25.07
VAC-0101433	B30-2	3/8" BSPP male	£25.07
VAC-0101475	B40	1/8" NPSF female	£31.05
VAC-0101470	B40	1/4" BSPP male	£31.05
VAC-0101472	B40	3/8" BSPP male	£31.05
VAC-0101636	B50	1/8" NPSF female	£37.10
VAC-0101631	B50	1/4" BSPP male	£37.10
VAC-0101633	B50	3/8" BSPP male	£37.10

**HNBR**

PART NUMBER	MODEL	THREAD	PRICE
VAC-9906875	B20	M5 female	£14.88

**HNBR WITH MESH FILTER**

VAC-9906877	B20	1/8" BSPP male	£15.25
VAC-0108078	B30-2	1/8" NPSF female	£37.58
VAC-0108167	B30-2	1/4" BSPP male	£37.58
VAC-0108168	B30-2	3/8" BSPP male	£37.58
VAC-0108082	B40	1/8" NPSF female	£42.58
VAC-0108169	B40	1/4" BSPP male	£42.58
VAC-0108170	B40	3/8" BSPP male	£42.58
VAC-0108171	B50	1/8" NPSF female	£54.64
VAC-0108172	B50	1/4" BSPP male	£54.64
VAC-0108173	B50	3/8" BSPP male	£54.64

**NBR-PVC WITH MESH FILTER**

VAC-0101890	B110	3/8" BSPP female	£95.05
VAC-0101892	B110	1/2" BSPP female	£95.05
VAC-0101931	B150	1/2" BSPP female	£127.77
VAC-0101932	B150	3/4" BSPP female	£127.77
VAC-0101675	B50-2	1/8" NPSF female	£28.30
VAC-0101670	B50-2	1/4" BSPP male	£28.30
VAC-0101672	B50-2	3/8" BSPP male	£28.30

Mesh filters available up to 110 mm

**DURAFLEX OB RANGE**

**OB FEATURES**

Oval suction cup with short bellows. Suitable for level adjustment. Can handle objects with height differences & varying shapes, for example embossed or corrugated plates. Lifting movement to separate small & thin objects.



VAC-0115291 comes complete with swivel fitting

Also available as Flat Concave version

**SUCTION CUP WITH SHORT BELLOWS**

**POLYURETHANE 60**

5020

PART NUMBER	MODEL	THREAD	PRICE
VAC-0115291	OB20x60P	1/8" BSPP male	£46.79
VAC-0108672	OB35x90P	3/8" NPSF female	£56.09
VAC-0108674	OB50x140P	3/8" NPSF female	£83.36
VAC-0108676	OB65x170P	3/8" NPSF female	£119.20

**POLYURETHANE 60 WITH MESH FILTER**

VAC-0108673	OB35x90P	3/8" BSPP male	£56.09
VAC-0108675	OB50x140P	3/8" BSPP male	£83.36
VAC-0108677	OB65x170P	3/8" BSPP male	£119.20

**POLYURETHANE 30 / 60**

VAC-0109857	OB35x90P	3/8" NPSF female	£59.36
VAC-0109859	OB50x140P	3/8" NPSF female	£93.08
VAC-0109861	OB65x170P	3/8" NPSF female	£133.00

**POLYURETHANE 30 / 60 WITH MESH FILTER**

VAC-0109856	OB35x90P	3/8" BSPP male	£59.36
VAC-0109858	OB50x140P	3/8" BSPP male	£93.08
VAC-0109860	OB65x170P	3/8" BSPP male	£133.00

**DURAFLEX BX RANGE**

**BX FEATURES**

Suitable for level adjustment & for uneven & porous surfaces, such as cardboard, plastic, glass, metals, etc. Polyurethane yellow / green offers a softer sealing lip, yet strong & stable bellows-unsealed media.

- Specially formulated to offer elasticity of rubber with wear resistance of polyurethane
- Pliable suction cup with high stability & durability
- Silicone & mark free
- Hard wear resistance



**SUCTION CUP WITH 2 1/2" BELLOWS  
POLYURETHANE 30 / 60**

5020

PART NUMBER	MODEL	THREAD	PRICE
VAC-0122869	BX10P	M5 male	£11.98
VAC-0124344	BX15P	M5 male	£14.56
VAC-0125104	BX20P	M5 female	£23.84
VAC-0125108	BX20P	1/8" BSPP male	£24.21
VAC-0106293	BX75P	1/8" NPSF female	£54.68

**POLYURETHANE 30 / 60 WITH FILTER**

PART NUMBER	MODEL	THREAD	PRICE
VAC-0109404	BX25P	M5 female	£32.42
VAC-0109402	BX25P	1/8" BSPP male / M5 female	£32.42
VAC-0106604	BX35P	1/8" NPSF female	£38.62
VAC-0104727	BX52P	1/8" NPSF female	£47.01
VAC-0107151	BX75P	3/8" BSPP male	£70.44
VAC-0108273	BX100P	3/8" BSPP male	£125.80

**POLYURETHANE 30 / 60 WITH MESH FILTER**

PART NUMBER	MODEL	THREAD	PRICE
VAC-0114449	BX35P	1/4" BSPP male	£39.21
VAC-0107377	BX35P	3/8" BSPP male	£39.21
VAC-0106045	BX52P	1/4" BSPP male	£47.91
VAC-0106740	BX52P	3/8" BSPP male	£47.91

**POLYURETHANE 60**

PART NUMBER	MODEL	THREAD	PRICE
VAC-0122967	BX10P	M5 male	£10.50
VAC-0124345	BX15P	M5 male	£13.20
VAC-0125109	BX20P	M5 female	£22.48
VAC-0125112	BX20P	1/8" BSPP male	£22.85

**POLYURETHANE 60 WITH FILTER**

PART NUMBER	MODEL	THREAD	PRICE
VAC-0109400	BX25P	M5 female	£30.09
VAC-0109398	BX25P	1/8" BSPP male / M5 female	£30.09
VAC-0107561	BX35P	1/8" NPSF female	£36.02
VAC-0107383	BX52P	1/8" NPSF female	£43.36
VAC-0107149	BX75P	3/8" BSPP male	£64.44
VAC-0108341	BX100P	3/8" BSPP male	£116.21

**POLYURETHANE 60 WITH MESH FILTER**

PART NUMBER	MODEL	THREAD	PRICE
VAC-0107379	BX35P	3/8" BSPP male	£36.61
VAC-0107385	BX52P	1/4" BSPP male	£44.26
VAC-0107387	BX52P	3/8" BSPP male	£44.26

**DURAFLEX BL RANGE**

**BL FEATURES**

- Suction cup with long bellows
- Suitable for level adjustment
- Lifting movement to separate small & thin objects
- Less suitable when the lifting force is parallel to the surface of the object
- For direct food contact
- Ideal for use with baked goods
- Metal detectable



**SUCTION CUP WITH LONG BELLOWS  
CHLOROPRENE**

5020

PART NUMBER	MODEL	THREAD	PRICE
VAC-0101193	BL20-2	M5 female	£15.34

**CHLOROPRENE WITH MESH FILTER**

PART NUMBER	MODEL	THREAD	PRICE
VAC-0101194	BL20-2	1/8" BSPP male	£15.71
VAC-0101501	BL30-2	1/8" NPSF female	£21.17
VAC-0101496	BL30-2	1/4" BSPP male	£21.17
VAC-0101527	BL40-2	1/8" NPSF female	£24.84
VAC-0101522	BL40-2	1/4" BSPP male	£24.84
VAC-0101701	BL50-2	1/8" NPSF female	£30.34
VAC-0101696	BL50-2	1/4" BSPP male	£30.34

**SILICONE**

PART NUMBER	MODEL	THREAD	PRICE
VAC-0101204	BL20-2	M5 female	£20.43

**SILICONE WITH MESH FILTER**

PART NUMBER	MODEL	THREAD	PRICE
VAC-0101205	BL20-2	1/8" BSPP male	£20.80
VAC-0101514	BL30-2	1/8" NPSF female	£27.47
VAC-0101509	BL30-2	1/4" BSPP male	£27.47
VAC-0101540	BL40-2	1/8" NPSF female	£33.43
VAC-0101535	BL40-2	1/4" BSPP male	£33.43
VAC-0101714	BL50-2	1/8" NPSF female	£41.02
VAC-0101709	BL50-2	1/4" BSPP male	£41.02

**Do you also need?**



**Duraflex Range  
DCF, BFF, OBF,  
FCF, OCF, BFFT**

Available on request, please contact your distributor for further information.

FDA APPROVED – F-FDA RANGE

F-FDA FEATURES

The material used is food grade silicone. It is free from colour pigments, approved by FDA (FDA 21 CFR 177.2600.) & meets EU's regulation EU 1935/2004. The cup is soft & pliable & can operate at a wide temperature range.

FLAT SUCTION CUP

SILICONE

5020

PART NUMBER	MODEL	THREAD	PRICE
VAC-9909623	F15FCM	M5 male	£8.08
VAC-0200263	F15FCM	-	£6.25
VAC-0200417	F20FCM	-	£8.02
VAC-0200439	F25FCM	-	£8.92
VAC-0200418	F30-2FCM	-	£9.49
VAC-0200437	F40-2FCM	-	£12.07
VAC-0200438	F50-2FCM	-	£14.25
VAC-0200264	F75FCM	-	£22.87
VAC-0200302	F110FCM	-	£38.77
VAC-0200265	F150FCM	-	£58.08
VAC-0201216	F26FCM	-	£6.39
VAC-0200328	F33FCM	-	£6.98



SILICONE WITH MESH FILTER

PART NUMBER	MODEL	THREAD	PRICE
VAC-9909710	F20FCM	1/8" BSPP male / M5 female	£16.13
VAC-9909624	F20FCM	1/8" BSPP male	£16.13
VAC-9909711	F25FCM	1/8" BSPP male / M5 female	£17.02
VAC-9909625	F25FCM	1/8" BSPP male	£17.02
VAC-9909627	F30-2FCM	1/8" BSPP male / M5 female	£17.59
VAC-9909626	F30-2FCM	1/8" BSPP male	£17.59
VAC-9909628	F40-2FCM	1/4" BSPP male	£22.69
VAC-9909630	F50-2FCM	1/4" BSPP male	£27.22
VAC-0200497	F75FCM	3/8" BSPP female	£61.86
VAC-0200504	F110FCM	1/2" BSPP female	£96.80
VAC-0200507	F150FCM	1/2" BSPP female	£124.41
VAC-9914238	F26FCM	1/4" BSPP male	£12.81
VAC-9914237	F33FCM	1/4" BSPP male	£13.39

FDA APPROVED – B-FDA RANGE

B-FDA FEATURES

The material is approved by FDA (FDA 21 CFR 177.2600.) & meets EU's regulation EU 1935/2004. Most of the cups are transparent with no addition of pigments.

FLAT SUCTION CUP

SILICONE

5020

PART NUMBER	MODEL	THREAD	PRICE
VAC-9909604	B5FCM	M5 male	£7.48
VAC-0200277	B5FCM	-	£5.82
VAC-9909605	B8FCM	M5 male	£8.28
VAC-0200278	B8FCM	-	£6.62
VAC-9909606	B10-2FCM	M5 male	£9.42
VAC-0200241	B10-2FCM	-	£7.60
VAC-9909607	B15-2FCM	M5 male	£10.31
VAC-0200271	B15-2FCM	-	£8.49
VAC-0200405	B20FCM	-	£11.20
VAC-0200407	B30-2FCM	-	£14.45
VAC-0200408	B40FCM	-	£20.43
VAC-0200409	B50FCM	-	£24.13



SILICONE WITH MESH FILTER

PART NUMBER	MODEL	THREAD	PRICE
VAC-9909700	B20FCM	1/8" BSPP male / M5 female	£19.30
VAC-9909608	B20FCM	1/8" BSPP male	£19.30
VAC-9909609	B30-2FCM	1/4" BSPP male	£25.07
VAC-9909611	B40FCM	1/4" BSPP male	£31.05
VAC-9909614	B50FCM	1/4" BSPP male	£37.10

Other sizes available on request

Do you also need?



FCX suction cups

The FCX50 suction cup features a multi-lip design that ensures a secure grip on surfaces with indents and protrusions. It requires low vacuum levels to grip items such as fruits firmly and gently, which helps deliver pristine products to customers.



Available on request, please contact your distributor for further information.

## B-BL FOOD RANGE

### B-BL FEATURES

Cups of food contact materials (FCM), suitable for handling bread & pastries. In addition to threaded, separable stainless steel & plastic fittings, all cups are available with a retainer clip, which will fit standard bread depanners. The BBL cups can handle great differences in levels, due to the long bellows. The silicone material complies with FDA 21 CFR 177.2600 & EU 1935/2004. Not suitable for use with deep vacuum levels.



### FCM SUCTION CUP WITH 4 1/2" BELLOWES SILICONE DETECTABLE

5020

PART NUMBER	MODEL	THREAD	PRICE
VAC-0206373	B-BL30-2	Pad only	£4.86
VAC-0202850	B-BL40-2	Pad only	£5.55
VAC-0206374	B-BL60-2	Pad only	£11.10

### SILICONE DETECTABLE / COMPOSITE

PART NUMBER	MODEL	THREAD	PRICE
VAC-0207097	B-BL30-2	3/8" BSPP male	£18.09
VAC-0207099	B-BL30-2	3/8" NPT male	£18.09
VAC-0207096	B-BL30-2	1/2" BSPP male	£18.09
VAC-0207098	B-BL30-2	1/2" NPT male	£18.09
VAC-0207100	B-BL30-2	Retainer clip	£6.89
VAC-0207105	B-BL40-2	3/8" BSPP male	£18.78
VAC-0207107	B-BL40-2	3/8" NPT male	£18.78
VAC-0207106	B-BL40-2	1/2" BSPP male	£18.78
VAC-0207108	B-BL40-2	1/2" NPT male	£18.78
VAC-0207109	B-BL40-2	Retainer clip	£7.58
VAC-0207114	B-BL60-2	3/8" BSPP male	£24.33
VAC-0207117	B-BL60-2	3/8" NPT male	£24.33
VAC-0207115	B-BL60-2	1/2" BSPP male	£24.33
VAC-0207118	B-BL60-2	1/2" NPT male	£24.33
VAC-0207119	B-BL60-2	Retainer clip	£13.14

## F-BX FOOD RANGE

### F-BX FEATURES

The 2 1/2" bellows F-BX cups of food contact materials (FCM) have a 'funnel' shape design with very thin lips, but with stable body / bellows. This allows for excellent grip on different food parts with irregular surfaces & different heights, even at fast speeds & accelerations. F-BX is suitable for frozen food as well as raw food. The silicone material complies with FDA 21 CFR 177.2600 & EU 1935/2004.



### FCM SUCTION CUP WITH 2 1/2" BELLOWES SILICONE DETECTABLE / COMPOSITE

5020

PART NUMBER	MODEL	THREAD	PRICE
VAC-0207052	F-BX10	M5 male	£14.42
VAC-0207053	F-BX10	1/8" BSPP male	£16.31
VAC-0207054	F-BX10	1/8" NPT male	£16.31
VAC-0207059	F-BX15	1/8" BSPP male	£17.01
VAC-0207061	F-BX15	1/8" NPT male	£17.01
VAC-0207060	F-BX15	1/4" BSPP male	£17.01
VAC-0207062	F-BX15	1/4" NPT male	£17.01
VAC-0207067	F-BX20	1/8" BSPP male	£17.71
VAC-0207069	F-BX20	1/8" NPT male	£17.71
VAC-0207068	F-BX20	1/4" BSPP male	£17.71
VAC-0207070	F-BX20	1/4" NPT male	£17.71
VAC-0207075	F-BX25	1/4" BSPP male	£18.41
VAC-0207077	F-BX25	1/4" NPT male	£18.41
VAC-0207076	F-BX25	3/8" BSPP male	£18.41
VAC-0207078	F-BX25	3/8" NPT male	£18.41
VAC-0207083	F-BX35	1/4" BSPP male	£19.80
VAC-0207085	F-BX35	1/4" NPT male	£19.80
VAC-0207084	F-BX35	3/8" BSPP male	£19.80
VAC-0207086	F-BX35	3/8" NPT male	£19.80

## F-OB FOOD RANGE

### F-OB FEATURES

The small oval bellow cups of food contact material (FCM) are suitable for the handling of long & narrow food objects when maximum lifting force is desired. They are suitable for irregular surfaces & when level compensation is desired. This programme of oval cups has characteristics that are especially suited for food contact handling. The silicone material complies with FDA 21 CFR 177.2600 & EU 1935/2004.



### FCM SUCTION CUP WITH 1 1/2" BELLOWES SILICONE DETECTABLE / STAINLESS STEEL

5020

PART NUMBER	MODEL	THREAD	PRICE
VAC-0205912	F-OB 10x30	1/8" BSPP male	£49.04
VAC-0205920	F-OB 30x60	1/8" BSPP male	£63.05
VAC-0205923	F-OB 30x60	1/4" BSPP male	£63.05

### SILICONE / STAINLESS STEEL

VAC-0207044	F-OB 10x30	1/8" BSPP male	£40.84
-------------	------------	----------------	--------

### SILICONE DETECTABLE / STAINLESS STEEL

VAC-0205918	F-OB 20x40	1/8" BSPP male	£56.05
VAC-0205915	F-OB 20x40	1/4" BSPP male	£56.05

### SILICONE NON-DETECTABLE / STAINLESS STEEL

VAC-0207046	F-OB 20x40	1/8" BSPP male	£47.65
VAC-0207045	F-OB 20x40	1/4" BSPP male	£47.65
VAC-0207047	F-OB 30x60	1/8" BSPP male	£54.46
VAC-0207048	F-OB 30x60	1/4" BSPP male	£54.46

# PIAB Value Line

## Impressive performance at an affordable price

Piab has vast experience across various applications and industries, from picking and placing tiny items to handling large, heavy boxes.

Partnering with Piab means more than having a reliable vacuum solutions supplier; they aim to increase productivity, reduce energy consumption, and improve working environments.

## Value Line

Piab has historically concentrated on developing products and taking the lead in vacuum applications that are challenging or demanding.

They have expanded their focus to more straightforward applications, such as case erectors, sheet metal loading, and injection moulding, with less challenging surfaces to grip.

The new product line is named Value Line and offers optimal performance at an affordable price. They are available to purchase as a single unit or in multi-packs.

## Typical applications for Value Line

- Sheet metal loading
- Case erecting
- Injection moulding

Piab's other lines of suction cups, such as piGRIP® and DURAFLEX®, are still available for more challenging applications.

## Value Line®



Contact your distributor for further details



## VALUE LINE BRASS FITTINGS FOR CUPS

### SPECIFICATIONS

Temperature	0 – 60/80* °C
Material	TPE-U
Colour	Purple

\* Max. temperature short term contact, 10 sec & 50% intermittence, ambient temperature 15 – 30°C, mechanical properties will start to degrade.

### FITS CUPS

VAC-0202096	VAC-0202100	VAC-0202102
VAC-0202097	VAC-0202101	VAC-0202103
VAC-0202099	VAC-0202113	VAC-0202115
VAC-0202109	VAC-0202114	VAC-0202116
VAC-0202110	VAC-0202120	VAC-0202122
VAC-0202111	VAC-0202121	VAC-0202123
VAC-0202117		
VAC-0202118		
VAC-0202119		

Please note:  
Additional Piab items  
also available to  
order upon request

## BRASS FITTINGS FOR CUPS

### 6 MM



5020

PART NUMBER	SIZE & THREADS	DIM E	DIM F	DIM G	SW	PRICE
VAC-0202156	1/8" BSPP – M5 BSPP	11	23	3	3	£7.57
VAC-0202157	1/4" BSPP – 1/8" BSPP	14	26	3	3	£7.57
VAC-0202164	1/8" NPT – M5 NPSF	10	22	n/a	3	£9.46
VAC-0202163	1/4" NPT – 1/8" NPSF	15	27	n/a	3	£10.40

### 10 MM

VAC-0202158	1/4" BSPP – 1/8" BSPP	15	35	4	6	£9.46
VAC-0202160	3/8" BSPP – 1/4" BSPP	15	35	4	6	£7.57
VAC-0202164	1/4" NPT – 1/8" NPSF	15	35	n/a	6	£9.46
VAC-0202166	3/8" NPT – 1/4" NPSF	15	35	n/a	6	£9.46

### 12 MM

VAC-0202159	1/4" BSPP – 1/8" BSPP	15	40	4	6	£10.40
VAC-0202165	3/8" BSPP – 1/4" BSPP	15	40	4	6	£10.40
VAC-0202161	1/4" NPT – 1/8" NPSF	15	39	n/a	6	£7.57
VAC-0202167	3/8" NPT – 1/4" NPSF	15	39	n/a	6	£10.40



## piINLINE® Eco-friendly, energy saving, inline vacuum ejector

Introducing piINLINE® a range of eco-friendly, vacuum inline ejectors based on Piab's energy efficient COAX® technology.

- Superior vacuum performance even at low or fluctuating feed pressures.
- Dirt tolerant & durable design.
- Easy to retrofit existing energy wasting inline vacuum ejectors, thanks to generic 'plug-&-play' design.
- Easy & simple installation with push in connections – low installation cost.
- Installs directly on the hose near the suction point.
- Eliminates flow losses & enhances the vacuum performance.

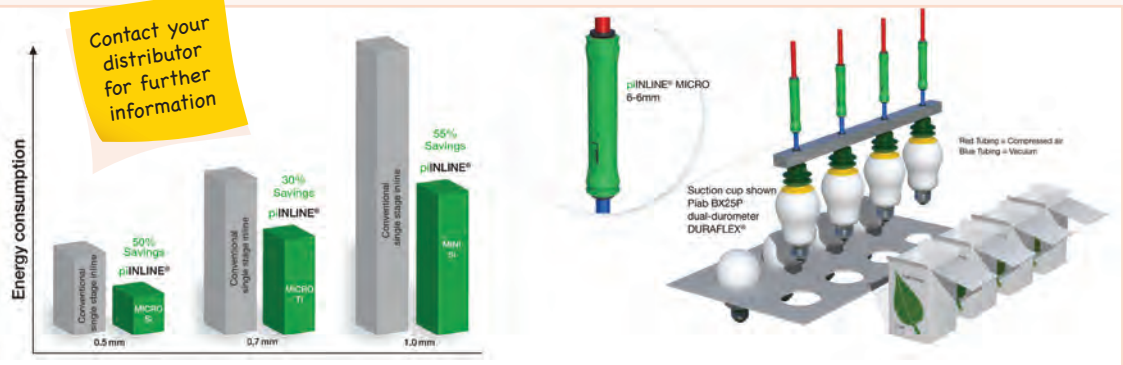

### TECHNICAL INFORMATION

piINLINE® vacuum ejector	Area of application	Dirt tolerant design	Optimum feed pressure	Air Consumption	Max. vacuum	Max. vacuum flow	Evacuation time, -50 kPa	
			MPa	NI/min	-kPa	NI/min	s/l	
	MICRO Si	Leaking applications	0.600	7.2	75	16.8	4.90	
	MICRO Bi	Low or fluctuating compressed air	0.180	8.4	83	13.8	10.00	
	MICRO Ti	Sealed applications	0.400	16.2	84	19.2	3.10	
	MICRO Xi	Leaking applications	x	0.600	22.2	75	18.6	2.60
	MICRO Xi	Sealed applications	0.500	7.8	92	14.4	7.30	
	MINI Si	Leaking applications	x	0.600	26.4	75	41.4	1.40
	MINI Pi	Low or fluctuating compressed air	x	0.314	26.4	90	34.2	1.80
	MINI Xi	Sealed applications	x	0.500	27.6	94	37.2	1.60
	MIDI Si	Leaking applications	x	0.600	105.0	75	186.0	0.40
	MIDI Pi	Low or fluctuating compressed air	x	0.300	120.0	90	162.0	0.48
	MIDI Xi	Sealed applications	x	0.450	110.0	95	168.0	0.44

### ORDERING INFORMATION

piINLINE® vacuum ejector	Connections for compressed air & vacuum				Accessories		
	4 – 4 mm	6 – 6 mm	8 – 8 mm	8 – 12 mm	Snap in mounting	Silencer	Snap in mounting for Silencer
	MICRO Si	0122882	-	-	5xMICRO 0123093	-	-
	MICRO Bi	0122880	0122883	-			
	MICRO Ti	-	0122022	-			
	MICRO Xi	0122881	0122884	-			
	MINI Si	-	0122025	0122896	4xMINI 0123094	0125466	1xMINI 0126009
	MINI Pi	-	0122894	0122897			
	MINI Xi	-	0122895	0122898			
	MIDI Si	-	-	0122032	1xMIDI 0123095	0123031	1xMIDI 0123096
	MIDI Pi	-	-	0122899			
	MIDI Xi	-	-	0122900			

Leaking applications include handling porous materials such as corrugated board.  
Sealed applications include handling electronics, plastic parts & other non-porous materials.



New

# PIAB piSAFE®

PIAB's piSAFE® product range is designed to provide low-weight and configurable products that can be easily adapted to meet application needs. Despite the flexible design, these products are built with Piab's patented COAX technology, ensuring market-leading vacuum performance.

The piSAFE® range is an excellent choice for demanding robotic applications and ergonomic handling devices thanks to its high vacuum, safe, and high-performing configuration.

Whether you require a centralised or decentralised vacuum system, EOAT or stand-alone system, Piab's piSAFE® range is specified to deliver the best possible performance while being easy to maintain.

Contact your distributor for further information



New

# PIAB Kenos® Vacuum Gripping Systems

Kenos® is a renowned brand that specialises in producing large-area vacuum grippers. These grippers are designed and optimised to cater to various industries such as packaging, wood, food, etc. This range of vacuum grippers provides a flexible solution for handling and manipulating products with different shapes, dimensions, and compact sizes.

Most of the gripping systems are equipped with an integrated vacuum generator or are suitable for separated vacuum generation using a pump or side channel blower. The integrated vacuum generator comes with a modular multi-stage COAX® ejector that is easy to maintain and is the most energy-efficient ejector technology in the market.

The number of ejectors can be increased even after installation if necessary. The mat of the KVG gripping system is made of technical foam (FDA-approved mat available) with different pitch holes and thicknesses. Alternatively, the KVG gripping system can be equipped with suction cups, size 35 – 60 mm, from the DURAFLEX® or Value Line® series.



VACUUM GRIPPER SYSTEM – VGS™

ENABLES EASY SELECTION & ACCURATE DIMENSIONING

Piab's decentralised vacuum gripper system, VGS, is a product solution, integrating high quality suction cups with COAX cartridges.

- VGS makes selection, sizing & installation of a vacuum system much easier. Design & dimension errors will be avoided.
- You will enjoy the benefits of a more efficient & reliable vacuum system.
- Increased machine speeds can be achieved, thanks to faster response times, with the vacuum source right at the cup & better initial vacuum flow, which will grip the object faster.
- The decentralised approach provides safety with one vacuum source per suction point. It also eliminates flow losses in long vacuum hoses, making maximum use of energy.
- VGS 3040 with integrated energy saving functions, like Vacustat & AQR02 (Atmospheric Quik Release) is a pioneering product & the world's most energy efficient concept for vacuum handling of sealed parts, such as glass & metal sheets.

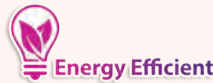

energy savers

piSAVE optimise



- Vacuum controlled proportional pressure regulator, a fully pneumatic device suitable for air driven ejectors / pumps.
- The feed pressure to the vacuum pump / ejector is automatically regulated & controlled to maintain the set vacuum level. Air / energy usage is kept to a minimum for the application (optimised).
- Recommended for leaking & sealed applications to save energy & secure the right vacuum level.
- Extra port for vacuum gauge.
- Air ventilation port with filter.
- Swivel compressed air connections.
- piSAVE optimise gives maximum feed pressure/flow to vacuum pump / ejector until vacuum level starts to build up.
- Separate mounting bracket kit.
- Upgrade kit – available as an integrated module for piCLASSIC & Classic vacuum pumps.

piSAVE on / off



- Independent pneumatic air saving device for vacuum pumps.
- Adjustable vacuum controlled 2/2 NO valve.
- Available with large hysteresis for object handling & small hysteresis for process applications.
- The Vacustat is recommended for vacuum pumps in non-leaking systems.
- The vacuum pump must be fitted with a non-return valve.

piSAVE release



- Equalises pressure in the suction cups to provide fast release of the product.
- Extra fast release by accumulating & utilising the feed air pressure as a boost.
- On / off activated simultaneously with the ejector.
- No additional controls required – use a single 3/2 control valve for the ejector & piSAVE release.

piSAVE sense



- Vacuum check valves, which allow a few suction cups to miss the object(s) & still maintain enough vacuum level in the system with quick response & release times.
- The vacuum check valves shall be used in a centralised vacuum system, one for each suction cup.
- Designing with vacuum check valves will require a smaller vacuum pump & save energy.
- Suitable for handling different sized or a different number of leaking objects, such as MDF boards, corrugated cardboards, with a flexible handling device.
- Also suitable for objects with surface leakage around the lip of the suction cup.
- Available in three sizes with different flow performance / characteristics to suit different degrees of leakage.
- The valves are integrated in an AI-fitting with female & male threaded connections to facilitate installation.

**NYLON VACUUM FILTERS**

**DESCRIPTION**

To filter dust & other small particles from the vacuum flow. Reduces the risk of operation breakdown or stoppage in the pump.

**FEATURES**

- To filter dust & other small particles from the vacuum flow
- Reduces the risk of operation breakdown or stoppage in the pump
- Replaceable filter element
- Available with special filter element with increased filter area
- Material: PA, PP, SS, PL
- Temperature: -20°C to +80°C

**APPLICATIONS**

- Case / carton erecting, case / carton opening closing
- Tray forming, tray unloading & loading
- Direct food contact



**VACUUM FILTERS  
NYLON**

5020

PART NUMBER	SIZE	FILTRATION	MAX. FLOW RATE	PRICE
VAC-0110521	1/2" BSPP	5 micron	5.8 nl/s	£146.03
VAC-0110522	3/4" BSPP	5 micron	5.8 nl/s	£146.03
VAC-0110523	1 1/2" BSPP	5 micron	9.0 nl/s	£247.54
VAC-3116670	1/8" BSPP	10 micron	1.4 nl/s	£63.80
VAC-3116671	3/8" BSPP	10 micron	2.5 nl/s	£63.80
VAC-3116651	1/2" BSPP	10 micron	15.0 nl/s	£79.33
VAC-3116652	3/4" BSPP	10 micron	15.0 nl/s	£79.33
VAC-3116672	1" BSPP	10 micron	42.0 nl/s	£122.63
VAC-3116653	1 1/2" BSPP	10 micron	85.0 nl/s	£131.75
VAC-0128408	1/8" NPT	10 micron	1.4 nl/s	£63.80
VAC-0128409	1/4" NPT	10 micron	1.4 nl/s	£63.80
VAC-0128410	3/8" NPT	10 micron	2.5 nl/s	£63.80
VAC-0128413	1/2" NPT	10 micron	15.0 nl/s	£79.33
VAC-0128415	3/4" NPT	10 micron	15.0 nl/s	£79.33
VAC-0128418	1" NPT	10 micron	42.0 nl/s	£122.63
VAC-0128419	1 1/2" NPT	10 micron	85.0 nl/s	£131.75

**STEEL VACUUM FILTERS**

**DESCRIPTION**

To filter dust & other small particles from the vacuum flow. Reduces the risk of operation breakdown or stoppage in the pump.

**FEATURES**

- To filter dust & other small particles from the vacuum flow
- Reduces the risk of operation breakdown or stoppage in the pump
- Material: BES, SS, NBR, PL
- Temperature: -30°C to +90°C

**APPLICATIONS**

- Case / carton erecting, case / carton opening closing
- Tray forming, tray unloading & loading
- Direct food contact



**VACUUM FILTERS  
STEEL**

5020

PART NUMBER	SIZE	FILTRATION	MAX. FLOW RATE	PRICE
VAC-3116709	1" BSPP	5 micron	16.5 nl/s	£421.01
VAC-3116654	1 1/2" BSPP	5 micron	37.7 nl/s	£494.65
VAC-3116710	2" BSPP	5 micron	82.6 nl/s	£502.86
VAC-0211036	2 1/2" BSPP	5 micron	100.0 nl/s	£533.90

## DESCRIPTION

The EOAT & gripper systems are used to design robotic end-effector tools, ergonomic tools or fixture tools for use on all types of automation equipment. The tooling consists of connecting parts for welded frames or extruded profiles & swivel arm assemblies, grippers with a choice of various 'function' attachments. Some function attachments include a vacuum ejector that is based on the latest COAX® technology. Piab provides both round & square EOAT as there are advantages with both options. To maximise the flexibility, our components are modular & adjustable & can be combined into a specific tool from the components. With our great expertise we can also provide tailor made solutions for various applications in the automotive, plastics & food industries.

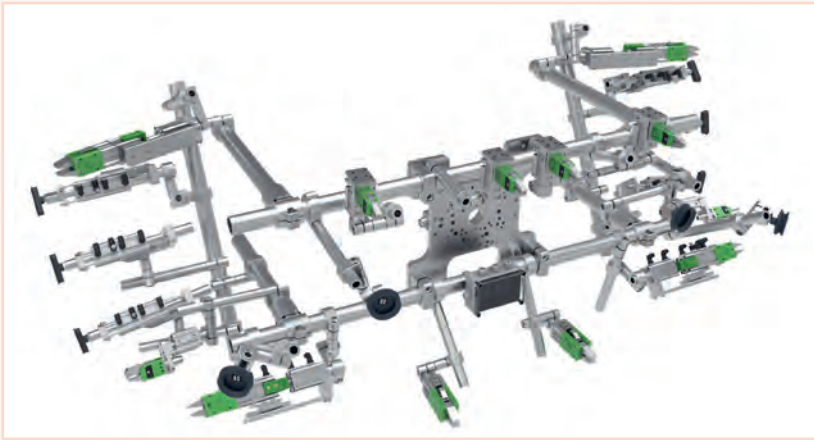

## GRIPPER FINGERS

### FEATURES

- Pneumatically single acting, spring return function
- Extendable for longer reach, using VLR Arm Extensions
- Fully compatible with SAS's modular EOAT gripper system

### GRIPPER FINGERS PNEUMATICALLY SINGLE ACTING SPRING RETURN FUNCTION



5020

PART NUMBER	MODEL	DEGREE	FORCE	PRICE
VAC-0213149	GRF 14-95	95° (E)	16 N	£162.90
VAC-0213152	GRF 20-95	95° (E)	16 N	£183.63

### GRIPPER FINGERS PNEUMATICALLY SINGLE ACTING SPRING RETURN FUNCTION



5020

PART NUMBER	MODEL	DEGREE	FORCE	PRICE
VAC-0213159	GRF 20-35	35° (E)	55 N	£197.27
VAC-0213160	GRF 30-35	35° (E)	55 N	£226.26

### GRIPPER FINGERS PNEUMATICALLY SINGLE ACTING SPRING RETURN FUNCTION



5020

PART NUMBER	MODEL	DEGREE	FORCE	PRICE
VAC-0213164	GRF 14-120	120° (E)	-	POA

### GRIPPER FINGERS PNEUMATICALLY SINGLE ACTING SPRING RETURN FUNCTION



5020

PART NUMBER	MODEL	DEGREE	FORCE	PRICE
VAC-0213165	GRF 20-120	120° (E)	-	POA

## FIXING DEVICES FOR GRIPPER FINGERS

### FIXING DEVICES FOR GRIPPING FINGERS RUBBERISED & SILICONE FREE LAYER



5020

PART NUMBER	MODEL	PRICE
VAC-0213400	GH-GF14D14	£27.74

### FIXING DEVICES FOR GRIPPING FINGERS RUBBERISED & SILICONE FREE LAYER



5020

PART NUMBER	MODEL	PRICE
VAC-0213401	GH-GF20D20	£27.74

## KNURLED & SAW TOOTH SPRUE / PART PLIERS

### FEATURES

- The standard-type jaws come with a knurled pattern on the jaw-face to better grip the sprue / part
- Single action spring return function
- Anodised finish
- Requirement: max. air pressure 87 psi (6 bar)
- Requirement: filtered dry air



### KNURLED SPRUE / PART PLIERS WITHOUT PNP SENSOR WITH PLUG

5020

### SAW TOOTH SPRUE / PART PLIERS

5020

PART NUMBER	MODEL	FORCE	SENSOR TYPE	PRICE
VAC-0213190	GRZ 10-10	20 N	N/A	£108.97
VAC-0213191	GRZ 10-12	20 N	N/A	£148.17

PART NUMBER	MODEL	FORCE	PRICE
VAC-0213196	GRZ 10-10 ST	20 N	£131.44
VAC-0213197	GRZ 10-12 ST	14.5 N	£131.44

### KNURLED SPRUE / PART PLIERS WITH PNP SENSOR WITH PLUG

5020



### SAW TOOTH SPRUE / PART PLIERS

5020

PART NUMBER	MODEL	FORCE	SENSOR TYPE	PRICE
VAC-0213353	GRZ 10-10 C-P8	20 N	SP1,5/SN1,5	£170.76
VAC-0213398	GRZ 10-12 C-P8	20 N	SP1,5/SN1,5	£170.76

PART NUMBER	MODEL	FORCE	PRICE
VAC-0213198	GRZ 20-16 ST	65 N	£167.39

## NBR PADDED SPRUE / PART PLIERS

### FEATURES

- The NP type jaws feature NBR padding to the jaws to prevent marring of finished parts
- Single action spring return function
- Anodised finish
- Requirement: max. air pressure 87 psi (6 bar)
- Requirement: filtered dry air



### NBR PADDED SPRUE / PART PLIERS

5020

### NBR PADDED SPRUE / PART PLIERS

5020

PART NUMBER	MODEL	FORCE	PRICE
VAC-0213202	GRZ 10-10 NP	–	£149.24
VAC-0213203	GRZ 10-12 NP	14.5 N	£134.81

PART NUMBER	MODEL	FORCE	PRICE
VAC-0213204	GRZ 20-16 NP	65 N	£185.37

## ELBOW ARMS

### FEATURES

- Angle adjustable elbow
- Useful for adjustment of GRZ gripper pliers & GRF gripper fingers



### GLA ELBOW ARMS

5020

PART NUMBER	MODEL	PRICE
VAC-0213090	GLA 14-120	£28.03



### GLA ELBOW ARMS

5020

PART NUMBER	MODEL	PRICE
VAC-0213089	GLA 10-90	£17.36



### GLA ELBOW ARMS

5020

PART NUMBER	MODEL	PRICE
VAC-0213092	GLA 20-150	£31.57



# FasTest Products

**FasTest quick connectors enhance in-process leak testing in a wide range of industries, including the ones below:**

## Manufacturing

FasTest's industry-leading quick connectors are designed explicitly for leak and pressure testing throughout manufacturing.

## HVAC-R

Manufacturers can use FasTest's high-flow OEM refrigerant valves for HVAC-R and their impressive range of connectors for refrigerant tubing and process tips in testing applications.

## Compressed gas

FasTest's high-speed CGA standard connectors are suitable for filling medical and industrial oxygen, propane, and other compressed gas cylinders.

## Calibration

Calibrate gauges, transmitters, and actuators faster with FasTest's connectors for instrumentation, compression fittings, flanges, conduit, and piping.

## Medical

FasTest's automated pneumatic and manual quick connectors are perfect for volume testing luers, tubing, syringes, catheters, and other medical device components.

## Automotive

Leak and pressure testing quick connectors are ideal for engines and automotive components.

## Fluid Power

FasTest's precision quick connectors are suitable for leak testing critical fluid power components or fluid transfer into / out of a system.

## Aerospace

A wide range of aerospace components can be leak-tested using FasTest's industry-leading precision quick connectors.

## Appliances

FasTest's quick connectors are ideal for leak-testing compressors, water systems, coils, heat exchangers, and other appliance components.

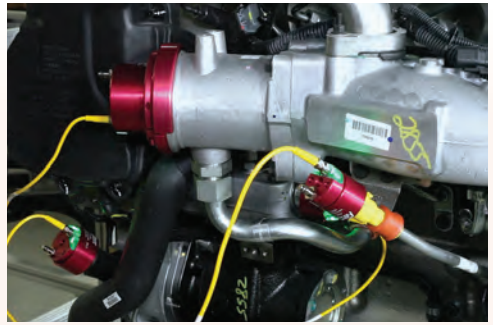

### DESCRIPTION

FasTest's EZ Series seal adjustable connectors provide fast, leak tight connections for pressure & vacuum testing, fluid filling & flushing applications from vacuum to 50 psi (3.44 bar). The industry best EZ Series seal connectors deliver fast, efficient seals by moving the bi-directional handle in either direction.

### FEATURES

- Simple adjustment – twist to adjust collar is easily sized for various seal diameters
- Quick change seal sets to accommodate multiple size tubing & port applications
- Simple design & 5 TIME field service maintenance kits require no special tools for easy seal replacement
- High flow design can be quickly adapted for plug style applications

### APPLICATIONS

- Radiators, hoses, reservoirs, plastic moulded components
- Plumbing fixtures, fuel tanks, pumps, filters, castings, fabricated housings
- Hydronic heating, engines, axles, transmissions, small appliances
- Pumps, tubing & assemblies

### SPECIFICATIONS

Connection type	Internal tubes / bores
Connection method	Lever actuated
Pressure rating	50 psi (3.4 bar)
Test pressure	Vacuum to 50 psi / 3.44 bar (clean & dry surface pneumatic applications)

### MATERIALS

Housing materials	Aluminium, stainless steel & moulded nylon handle
Seals	Neoprene (main), NBR (internal)



### INTERNAL MANUAL TUBE CONNECTOR



### LEVER ACTUATED WITH NEOPRENE MAIN SEALS

6410

PART NUMBER	SEALING RANGE	THREAD	BODY SIZE	PRICE
FASZN101	0.375" – 0.394"	1/8" NPT	1	£312.77
FASZN111	0.394" – 0.472"	1/8" NPT	1	£296.82
FASZN112	0.472" – 0.551"	1/8" NPT	1	£312.77
FASZN113	0.551" – 0.630"	1/8" NPT	1	£312.77
FASZN221	0.630" – 0.709"	1/4" NPT	2	£329.94
FASZN222	0.709" – 0.787"	1/4" NPT	2	£329.94
FASZN223	0.787" – 0.866"	1/4" NPT	2	£329.94
FASZN331	0.866" – 0.945"	1/4" NPT	3	£412.12
FASZN332	0.945" – 1.024"	1/4" NPT	3	£412.12
FASZN333	1.024" – 1.102"	1/4" NPT	3	£412.12
FASZN441	1.102" – 1.181"	3/8" NPT	4	£428.07
FASZN442	1.181" – 1.260"	3/8" NPT	4	£428.07
FASZN443	1.260" – 1.339"	3/8" NPT	4	£428.07

### MAINTENANCE KIT



### ZN SERIES MAINTENANCE KIT 5 COMPLETE REFURBISHMENTS

6410

PART NUMBER	FOR USE WITH	PRICE
FASZNB10360	FASZN101	£144.73
FASZNB111	FASZN111	£101.80
FASZNB112	FASZN112	£101.80
FASZNB113	FASZN113	£101.80
FASZNB221	FASZN221	£101.80
FASZNB222	FASZN222	£101.80
FASZNB223	FASZN223	£101.80
FASZNB331	FASZN331	£128.79
FASZNB332	FASZN332	£128.79
FASZNB333	FASZN333	£128.79
FASZNB441	FASZN441	£131.24
FASZNB442	FASZN442	£131.24
FASZNB443	FASZN443	£131.24



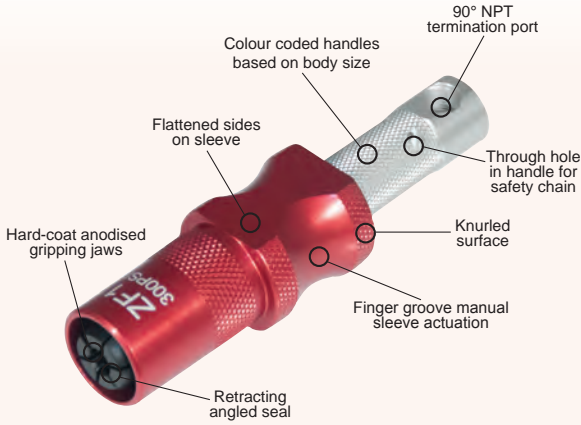

### SPECIFICATIONS

Operating pressure	Vacuum to 21 bar / 300 psi (ZF1-ZF4) 17 bar / 250 psi (ZF5)
Connection profile	External formed tubes (SAE J1231)
Termination profile	1/8" to 3/8" NPT
Operating temperature	-17°C to +93°C (0°F to 200°F)
Min / max bead depth (C)	0.13" / 0.32" (3.3 mm / 8.1 mm)
Minimum clearance (D)	0.31" (7.9 mm)

### MATERIALS

Housing, sleeve & components	Anodised aluminium
Main seal	70 durometer neoprene

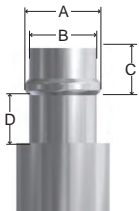

**EZ Connect ZF** incorporates a manual sleeve actuation to create a leak-tight external connection to a wide variety of formed tube styles. The ZF connectors are ideal for a diverse range of manufacturing testing systems.

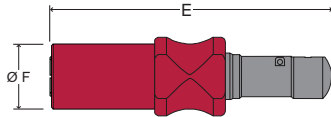

CONNECTOR	(E)	(Ø F)
ZF1	4.60" (116 mm)	0.98" (24.8 mm)
ZF2	4.90" (124 mm)	1.14" (28.9 mm)
ZF3	4.96" (126 mm)	1.23" (31.2 mm)
ZF4	5.18" (131 mm)	1.38" (35.0 mm)
ZF5	5.25" (133 mm)	1.55" (39.4 mm)

BODY SIZE	Ø BEAD DIA. RANGE (A)	TUBE DIA. RANGE (B)	SAE J1231	RATED PSI	TERMINATION PORT (90°)	Ø FLOW DIA.	MAIN SEAL PACK	REPAIR KIT
ZF1	Ø 0.310" – 0.400" 7.87 mm – 10.16 mm	Ø 0.25" – 0.34" 6.54 mm – 8.74 mm	-5	300	1/8" NPT	Ø 0.17" 4.3 mm	S-ZF1	R-ZF1
ZF2	Ø 0.400" – 0.490" 10.2 mm – 12.4 mm	Ø 0.34" – 0.44" 8.7 mm – 11.0 mm	-6	300	1/8" NPT	Ø 0.19" 4.8 mm	S-ZF2	R-ZF2
ZF3	Ø 0.490" – 0.580" 12.4 mm – 14.7 mm	Ø 0.44" – 0.52" 11.0 mm – 13.2 mm	-7 & -8	300	1/4" NPT	Ø 0.21" 5.3 mm	S-ZF3	R-ZF3
ZF4	Ø 0.580" – 0.670" 14.7 mm – 17.0 mm	Ø 0.52" – 0.61" 13.2 mm – 15.5 mm	-9	300	1/4" NPT	Ø 0.32" 8.1 mm	S-ZF4	R-ZF4
ZF5	Ø 0.670" – 0.760" 17.0 mm – 19.3 mm	Ø 0.61" – 0.70" 15.5 mm – 17.8 mm	-10	250	3/8" NPT	Ø 0.38" 9.6 mm	S-ZF5	R-ZF5

Colour coded handles simplifying operator selection when multiple SAE tube sizes are present

## DESCRIPTION

FasTest's EZ Connect ZF connectors provide fast, leak tight connections for pressure & vacuum testing, fluid filling & flushing applications from vacuum to 300 psi (20.68 bar). EZ Connect ZF is the newest quick connector in the EZ Connect Series & is designed to provide instant connections to a wide range of formed tube configurations for in-process testing.

## FEATURES

- Wide tolerance seal design provides fit to a range of tube diameters
- Lightweight aluminium body puts less strain on operator
- Finger grooves create an intuitive one-hand operation
- Self-aligning connector reduces connection failures
- Colour coded handles help operator identify correct connector
- Connectors fit in tight placements, providing improved fixture possibilities

## APPLICATIONS

- Engines & manifolds
- Radiators & reservoirs
- Castings
- Small appliances
- Lawn & garden products
- Plastic barbed tubes

## SPECIFICATIONS

Connection type	External tubes
Connection method	Sleeve actuated
Pressure ratings	F1-4: 300 psi (20.6 bar), F5: 250 psi (17.23 bar)

## MATERIALS

Seals	Neoprene
-------	----------



## EXTERNAL MANUAL TUBE CONNECTORS

### SLEEVE ACTUATED RED / SILVER



6410

PART NUMBER	SEALING RANGE	THREAD	BODY SIZE	PRICE
FASZF1	0.254" – 0.344"	1/8" NPT	ZF1	£889.25

### SLEEVE ACTUATED RED / BLACK



6410

PART NUMBER	SEALING RANGE	THREAD	BODY SIZE	PRICE
FASZF2	0.344" – 0.434"	1/8" NPT	ZF2	£918.68

### SLEEVE ACTUATED RED / BLUE



6410

PART NUMBER	SEALING RANGE	THREAD	BODY SIZE	PRICE
FASZF4	0.520" – 0.610"	1/4" NPT	ZF4	£980.01

### SLEEVE ACTUATED RED / GOLD



6410

PART NUMBER	SEALING RANGE	THREAD	BODY SIZE	PRICE
FASZF3	0.434" – 0.520"	1/4" NPT	ZF3	£967.75

### SLEEVE ACTUATED RED / GREEN



6410

PART NUMBER	SEALING RANGE	THREAD	BODY SIZE	PRICE
FASZF5	0.61" – 0.70"	3/8" NPT	ZF5	£1102.67

## REPLACEMENT SEAL SET



6410

### SEAL SET 5 SEALS

PART NUMBER	FOR USE WITH	PRICE
FASSZF1	FASZF1	£110.39
FASSZF2	FASZF2	£110.39
FASSZF3	FASZF3	£110.39
FASSZF4	FASZF4	£110.39
FASSZF5	FASZF5	£110.39

PUR seals available on request

## REPAIR KIT

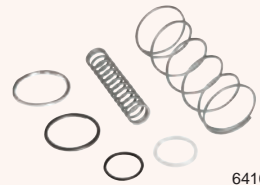

6410

### REPAIR KIT

PART NUMBER	FOR USE WITH	PRICE
FASRZF1	FASZF1	£56.42
FASRZF2	FASZF2	£56.42
FASRZF3	FASZF3	£56.42
FASRZF4	FASZF4	£56.42
FASRZF5	FASZF5	£56.42

## DESCRIPTION

FasTest External (FE) connectors deliver fast, leak free connections for vacuum & pressure testing, fluid filling or flushing applications. The FE quick connectors seal externally to a wide variety of smooth or threaded tubes, & the uniform seal movement makes a leak tight, quick connection, even over threaded, rough & oily surfaces. The connectors are ideal for automated processes & high volume production testing. Compressed air activates the seals for a full flow test with air, gas or liquid. Ideally suited to pick & place parts handling applications.



## SPECIFICATION

Connection type	External tubes
Connection method	Automated pneumatic
Pressure rating	500 psi (34.4 bar)
Test pressure	Vacuum to 500 psi
Pilot operation	60 – 90 psi air supply
<b>MATERIALS</b>	
Housing materials	Aluminium & stainless steel
Seal material	Neoprene

## EXTERNAL TUBE & THREAD



6410

## BASE CONNECTOR WITHOUT SEALS

PART NUMBER	SEALING RANGE	THREAD	BODY SIZE	PRICE
FASFEM001	0.050" – 0.080"	1/8" BSPP	001	POA
FASFEM01	0.100" – 0.510"	1/8" BSPP	01	£466.09
FASFEM1	0.433" – 0.827"	1/4" BSPP	1	£561.76
FASFEM2	0.787" – 1.510"	1/2" BSPP	2	£667.24
FASFEM3	1.496" – 1.969"	1" BSPP	3	£1202.02
FASFEM4	1.969" – 3.032"	1 1/8" BSPP	4	£1535.64

## REPAIR KIT



6410

## INTERNAL REPAIR KIT WITH NEOPRENE PISTON O-RINGS

PART NUMBER	FOR USE WITH	PRICE
FASFER001	FASFEM001	£18.40
FASFER01	FASFEM01	£20.85
FASFER1	FASFEM1	£20.85
FASFER2	FASFEM2	£23.30
FASFER3	FASFEM3	£41.70
FASFER4	FASFEM4	£46.61

## SEAL SETS



6410

## SEAL SET ONE COMPLETE SEAL CHANGE

PART NUMBER	FOR USE WITH	SEALING RANGE	PRICE
FASFES0010050	FASFEM001	0.030" – 0.050"	£207.29
FASFES001001	FASFEM001	0.050" – 0.080"	£125.11
FASFES001002	FASFEM001	0.080" – 0.130"	£125.11
FASFES0101	FASFEM01	0.100" – 0.180"	£55.19
FASFES0102	FASFEM01	0.180" – 0.260"	£55.19
FASFES0103	FASFEM01	0.260" – 0.340"	£55.19
FASFES0104	FASFEM01	0.340" – 0.420"	£55.19
FASFES0105	FASFEM01	0.420" – 0.510"	£55.19
FASFES115	FASFEM1	0.433" – 0.512"	£62.55
FASFES116	FASFEM1	0.512" – 0.591"	£62.55
FASFES117	FASFEM1	0.591" – 0.669"	£62.55
FASFES118	FASFEM1	0.669" – 0.750"	£62.55
FASFES119	FASFEM1	0.750" – 0.827"	£62.55
FASFES221	FASFEM2	0.787" – 0.866"	£103.03
FASFES222	FASFEM2	0.866" – 0.945"	£103.03
FASFES223	FASFEM2	0.945" – 1.024"	£103.03
FASFES224	FASFEM2	1.024" – 1.102"	£103.03
FASFES225	FASFEM2	1.102" – 1.181"	£103.03
FASFES226	FASFEM2	1.181" – 1.260"	£103.03
FASFES227	FASFEM2	1.260" – 1.339"	£103.03
FASFES228	FASFEM2	1.339" – 1.417"	£103.03
FASFES229	FASFEM2	1.417" – 1.510"	£103.03
FASFES331	FASFEM3	1.496" – 1.614"	£195.02
FASFES332	FASFEM3	1.614" – 1.732"	£195.02
FASFES333	FASFEM3	1.732" – 1.850"	£195.02
FASFES334	FASFEM3	1.850" – 1.969"	£195.02
FASFES441	FASFEM4	1.969" – 2.087"	£247.76
FASFES442	FASFEM4	2.087" – 2.205"	£247.76
FASFES443	FASFEM4	2.205" – 2.323"	£247.76
FASFES444	FASFEM4	2.323" – 2.441"	£247.76
FASFES445	FASFEM4	2.441" – 2.559"	£247.76
FASFES446	FASFEM4	2.559" – 2.677"	£247.76
FASFES447	FASFEM4	2.677" – 2.795"	£247.76
FASFES448	FASFEM4	2.795" – 2.913"	£247.76
FASFES449	FASFEM4	2.913" – 3.032"	£247.76

PUR seals available on request



6410

## BULK SEAL SET 5 REPLACEMENT SEALS

PART NUMBER	FOR USE WITH	SEALING RANGE	PRICE
FASFEB0010050	FASFEM001	0.030" – 0.050"	£44.16
FASFEB001001	FASFEM001	0.050" – 0.080"	£44.16
FASFEB001002	FASFEM001	0.080" – 0.130"	£44.16
FASFEB0101	FASFEM01	0.100" – 0.180"	£77.27
FASFEB0102	FASFEM01	0.180" – 0.260"	£77.27
FASFEB0103	FASFEM01	0.260" – 0.340"	£77.27
FASFEB0104	FASFEM01	0.340" – 0.420"	£77.27
FASFEB0105	FASFEM01	0.420" – 0.510"	£77.27
FASFEB115	FASFEM1	0.433" – 0.512"	£79.73
FASFEB116	FASFEM1	0.512" – 0.591"	£79.73
FASFEB117	FASFEM1	0.591" – 0.669"	£79.73
FASFEB118	FASFEM1	0.669" – 0.750"	£79.73
FASFEB119	FASFEM1	0.750" – 0.827"	£79.73
FASFEB221	FASFEM2	0.787" – 0.866"	£248.99
FASFEB222	FASFEM2	0.866" – 0.945"	£248.99
FASFEB223	FASFEM2	0.945" – 1.024"	£248.99
FASFEB224	FASFEM2	1.024" – 1.102"	£248.99
FASFEB225	FASFEM2	1.102" – 1.181"	£248.99
FASFEB226	FASFEM2	1.181" – 1.260"	£248.99
FASFEB227	FASFEM2	1.260" – 1.339"	£248.99
FASFEB228	FASFEM2	1.339" – 1.417"	£248.99
FASFEB229	FASFEM2	1.417" – 1.510"	£248.99
FASFEB331	FASFEM3	1.496" – 1.614"	£504.11
FASFEB332	FASFEM3	1.614" – 1.732"	£504.11
FASFEB333	FASFEM3	1.732" – 1.850"	£504.11
FASFEB334	FASFEM3	1.850" – 1.969"	£504.11
FASFEB441	FASFEM4	1.969" – 2.087"	£642.71
FASFEB442	FASFEM4	2.087" – 2.205"	£642.71
FASFEB443	FASFEM4	2.205" – 2.323"	£642.71
FASFEB444	FASFEM4	2.323" – 2.441"	£642.71
FASFEB445	FASFEM4	2.441" – 2.559"	£642.71
FASFEB446	FASFEM4	2.559" – 2.677"	£642.71
FASFEB447	FASFEM4	2.677" – 2.795"	£642.71
FASFEB448	FASFEM4	2.795" – 2.913"	£642.71
FASFEB449	FASFEM4	2.913" – 3.032"	£642.71

PUR seals available on request

### DESCRIPTION

FasTest Internal FIM (metric) connectors provide fast, leak free connections for vacuum & pressure testing, fluid filling or flushing applications. The FI quick connectors seal internally to a wide variety of smooth or threaded tubes & the uniform seal movement makes a leak tight connection, even into threaded, rough & oily surfaces. The connectors are activated by compressed regulated air acting on a piston, which expands an elastomeric seal to form a leak free connection. Testing, filling or flushing of the piece is accomplished by introducing air, liquid or gas media through the connector. Ideal for automated processes & high volume production testing, the FI Series connectors are suited to pick & place parts handling applications.



### FEATURES

- Pneumatic operation seals inside tubes & pipes
- Designed for production testing applications
- Pick & place parts handling
- Stroke limiter regulates seal expansion

### SPECIFICATION

Connection method	Automated pneumatic
Connection type	Internal tubes / bores
Pressure rating	120 psi (8.2 bar)
Test pressure	Vacuum to 120 psi
Pilot operation	60 – 90 psi air supply

### MATERIALS

Housing materials	Aluminium & stainless steel
Seal material	Neoprene

## INTERNAL TUBE & THREAD CONNECTOR



6410

### BASE CONNECTORS WITHOUT SEALS

PART NUMBER	SEALING SIZE	THREAD	BODY SIZE	PRICE
FASFIM01	0.310" – 0.394"	M5 x 0.8	01	£428.07
FASFIM1	0.394" – 0.630"	1/8" BSPP	1	£513.92
FASFIM2	0.630" – 0.866"	1/8" BSPP	2	£550.72
FASFIM3	0.866" – 1.102"	1/8" BSPP	3	£587.52
FASFIM4	1.102" – 1.339"	1/8" BSPP	4	£656.20
FASFIM5	1.339" – 1.693"	1/2" BSPP	5	£693.00
FASFIM6	1.693" – 2.165"	1/2" BSPP	6	£722.44

## REPAIR KIT



6410

### REPAIR KIT WITH SHAFTS & NEOPRENE O-RINGS

PART NUMBER	FOR USE WITH	PRICE
FASFIR01	FASFIM01	£22.08
FASFIR1	FASFIM1, FASFIM2	£22.08
FASFIR3	FASFIM3, FASFIM4	£22.08
FASFIR6	FASFIM5, FASFIM6	£26.98
FASFIR7	FASFIM7, FASFIM8	£28.21

## SEAL SETS



6410

### SEAL SET ONE COMPLETE SEAL CHANGE

PART NUMBER	FOR USE WITH	SEALING RANGE	PRICE
FASFIS010300	FASFIM01	0.310" – 0.330"	£88.31
FASFIS0101	FASFIM01	0.330" – 0.394"	£46.61
FASFIS111	FASFIM1	0.394" – 0.472"	£55.19
FASFIS112	FASFIM1	0.472" – 0.551"	£55.19
FASFIS113	FASFIM1	0.551" – 0.630"	£55.19
FASFIS221	FASFIM2	0.630" – 0.709"	£55.19
FASFIS222	FASFIM2	0.709" – 0.787"	£55.19
FASFIS223	FASFIM2	0.787" – 0.866"	£55.19
FASFIS331	FASFIM3	0.866" – 0.945"	£69.91
FASFIS332	FASFIM3	0.945" – 1.024"	£69.91
FASFIS333	FASFIM3	1.024" – 1.102"	£69.91
FASFIS441	FASFIM4	1.102" – 1.181"	£69.91
FASFIS442	FASFIM4	1.181" – 1.260"	£69.91
FASFIS443	FASFIM4	1.260" – 1.339"	£69.91
FASFIS551	FASFIM5	1.339" – 1.457"	£138.60
FASFIS552	FASFIM5	1.457" – 1.575"	£138.60
FASFIS553	FASFIM5	1.575" – 1.693"	£138.60
FASFIS661	FASFIM6	1.693" – 1.850"	£153.32
FASFIS662	FASFIM6	1.850" – 2.008"	£153.32
FASFIS663	FASFIM6	2.008" – 2.165"	£153.32

PUR seals available on request



6410

### BULK SEAL SET 5 REPLACEMENT SEALS

PART NUMBER	FOR USE WITH	SEALING RANGE	PRICE
FASFIB010300	FASFIM0101	0.310" - 0.330"	£152.09
FASFIB0101	FASFIM0101	0.330" - 0.394"	£87.08
FASFIB111	FASFIM111	0.394" - 0.472"	£89.54
FASFIB112	FASFIM112	0.472" - 0.551"	£89.54
FASFIB113	FASFIM113	0.551" - 0.630"	£89.54
FASFIB221	FASFIM221	0.630" - 0.709"	£90.76
FASFIB222	FASFIM222	0.709" - 0.787"	£90.76
FASFIB223	FASFIM223	0.787" - 0.866"	£90.76
FASFIB331	FASFIM331	0.866" - 0.945"	£125.11
FASFIB332	FASFIM332	0.945" - 1.024"	£125.11
FASFIB333	FASFIM333	1.024" - 1.102"	£125.11
FASFIB441	FASFIM441	1.102" - 1.181"	£136.15
FASFIB442	FASFIM442	1.181" - 1.260"	£136.15
FASFIB443	FASFIM443	1.260" - 1.339"	£136.15
FASFIB551	FASFIM551	1.339" - 1.457"	£336.07
FASFIB552	FASFIM552	1.457" - 1.575"	£336.07
FASFIB553	FASFIM553	1.575" - 1.693"	£336.07
FASFIB661	FASFIM661	1.693" - 1.850"	£336.07
FASFIB662	FASFIM662	1.850" - 2.008"	£336.07
FASFIB663	FASFIM663	2.008" - 2.165"	£336.07

PUR seals available on request

## DESCRIPTION

### ICON™ INTELLIGENT CONNECTION TECHNOLOGY

FasTest's ICON™ adds sensing capabilities to our mechanical sealing connection tools. ICON™ Tools include instant LED visual feedback & data output to improve sealing connection accuracy, maximise production efficiency, & optimise maintenance.

## FE & FI SERIES ICON™ CONNECTORS

### ICON™ features:



#### SURE SEAL™

Instant LED feedback verifies a good connection prior to starting a test.

#### SEAL LIFE™

Alert when the main seal is at end of life and must be replaced.

### System Overview:

**CONNECTED**

Green indication of a good connection.

**RECONNECT**

Recognize a connection issue before causing a false failure.

**WORN SEAL**

Alert when main seals should be replaced.

**PICK TOOL**

Controllable LED signals operator to use specific tool.

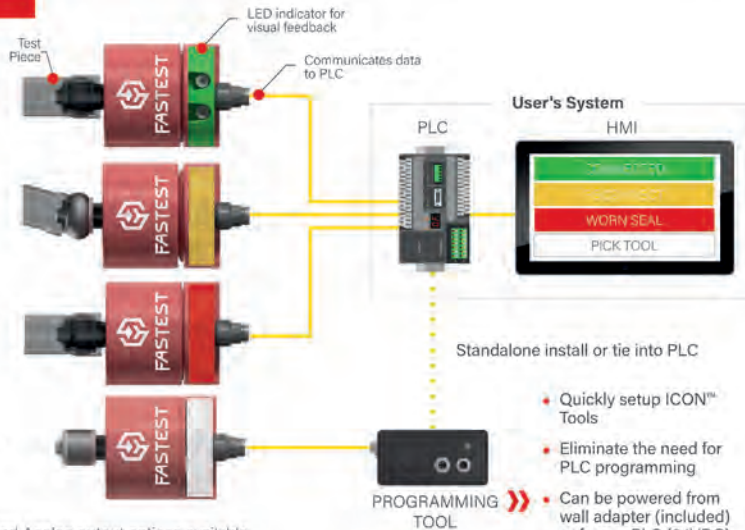

NOTE: Solid State Relay and Analog output options available.

### How To Add ICON™ to FI

Signal Output	Part Number Suffix	Example
FI without ICON™	None	FI01
FI with ICON™: Analog Output Signal	CV04ANA	FI01CV04ANA
FI with ICON™: Solid State Relay	CV04SSR	FI01CV04SSR

## FASMATE FX / FN SERIES ICON™ CONNECTORS

### ICON™ features:



#### SURE SEAL™

Instant LED feedback verifies a good connection prior to starting a test.

### System Overview:

**CONNECTED**

Verify connections are good prior to starting a leak test and provide operators instant positive feedback to simplify training.

**RECONNECT**

Recognize short connects before hazardous spills occur in functional testing, or prevent wasteful False Positive results in leak testing.

**PICK TOOL**

Controllable LED signals operator to use specific tool.

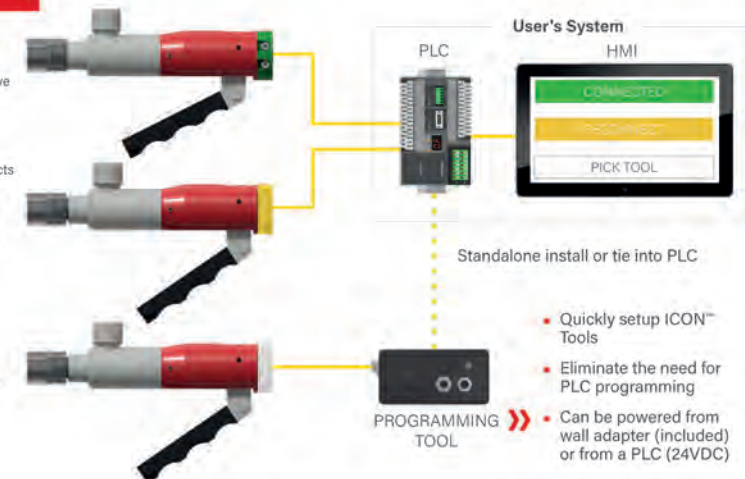

- Quickly setup ICON™ Tools
- Eliminate the need for PLC programming
- Can be powered from wall adapter (included) or from a PLC (24VDC)

## JNL SERIES

### DESCRIPTION

The JNL Series is ideal for internal connections to copper, steel & aluminium tubes used with manufacturing & refrigerant based products, such as heat exchangers, pressure vessels, gauges, valves, & HVAC-R systems. The unique collet gripping & sealing design seals reliably & resists removal under pressure. The single seal design can be quickly changed to minimise downtime, maintenance & tool inventory.



### FEATURES

- Instant connections from vacuum (10 micron) to 1000 psi
- Seals straight bore, step bore, smooth or cast surfaces
- Safety design feature prevents accidental disconnect under pressure
- Collet design provides maximum grip with minimum distortion of test piece
- Neoprene seals are standard for refrigerant based applications, but also available with any elastomer required for your application

### SPECIFICATION

Connection method	Lever actuated
Connection type	Internal tubes / bores
Pressure rating	68.8 bar (1000 psi)
Temperature range	-40°C to +121°C (-40°F to +250°F)

### MATERIALS

Housing materials	Aluminium, stainless steel & Delrin
Seal material	Neoprene

## INTERNAL TUBE & THREAD CONNECTOR



### BASE CONNECTORS WITH SEALS

6410

PART NUMBER	SEALING SIZE	THREAD	PRICE
FASJNL00375H	0.375"	1/8" NPT	£784.99
FASJNL00500H	0.500"	1/8" NPT	£784.99
FASJNL10625	0.625"	1/8" NPT	£784.99
FASJNL10750	0.750"	1/8" NPT	£794.80
FASJNL21000	1"	1/8" NPT	£1323.45

## SEAL SETS



### BULK SEAL SET

#### 5 REPLACEMENT SEALS

6410

PART NUMBER	FOR USE WITH	PRICE
FASSN00375H	FASJNL00375H	£53.97
FASSN00500H	FASJNL00500H	£53.97
FASSN10625	FASJNL10625	£53.97
FASSN10750	FASJNL10750	£53.97
FASSN21000	FASJNL21000	£53.97

## JXL SERIES

### DESCRIPTION

The JXL Series is ideal for external connections to copper, steel & aluminium tubes used with manufacturing & refrigerant based products, such as heat exchangers, pressure vessels, gauges, valves, & HVAC-R systems. The unique collet gripping & sealing design seals reliably & resists removal under pressure. The single seal design can be quickly changed to minimise downtime, maintenance & tool inventory.

### FEATURES

- Instant connections from vacuum (10 micron) to 1000 psi
- Seals straight bore, step bore, smooth or cast surfaces
- Safety design feature prevents accidental disconnect under pressure
- Collet design provides maximum grip with minimum distortion of test piece
- Neoprene seals are standard for refrigerant based applications, but also available with any elastomer required for your application

### SPECIFICATION

Connection method	Lever actuated
Connection type	Internal tubes / bores
Pressure rating	68.8 bar (1000 psi)
Temperature range	-40°C to +121°C (-40°F to +250°F)

### MATERIALS

Housing materials	Aluminium, stainless steel & Delrin
Seal material	Neoprene

## EXTERNAL TUBE & THREAD CONNECTOR



### BASE CONNECTORS WITH SEALS

6410

PART NUMBER	SEALING SIZE	THREAD	PRICE
FASJXL00250	0.250"	1/8" NPT	£398.63
FASJXL00375	0.375"	1/8" NPT	£398.63
FASJXL00500	0.500"	1/8" NPT	£398.63
FASJXL10625	0.625"	1/4" NPT	£693.00
FASJXL10750	0.750"	1/4" NPT	£796.03
FASJXL10875	0.875"	1/4" NPT	£796.03

## SEAL SETS



### BULK SEAL SET

#### 5 REPLACEMENT SEALS

6410

PART NUMBER	FOR USE WITH	PRICE
FASSXL00250	FASJXL00250	£68.69
FASSXL00375	FASJXL00375	£68.69
FASSXL00500	FASJXL00500	£68.69
FASSXL10625	FASJXL10625	£68.69
FASSXL10750	FASJXL10750	£68.69
FASSXL10875	FASJXL10875	£68.69

**DESCRIPTION**

FasTest's patented squeeze lever actuation & split collet design, of the FasMate FN Series connectors, provides an instant connection that can significantly decrease the time needed for pressure & vacuum testing, filling, flushing & performance testing. The squeeze lever / split collet operation uses no thread sealant, no wrench tightening & will not damage the port threads. Its rugged design is ideal for production use & FN Series offers the following actuation methods: squeeze lever, pneumatic pilot or pneumatic thumb latch.

**FEATURES**

- Instant connection to threaded ports
- Seals to 5000 psi for pneumatic / hydraulic testing
- Safe, reliable, leak tight connection
- Eliminates thread or product damage, sealant, & wrench tightening
- Durable stainless steel construction
- Available in multiple thread profiles

**SPECIFICATION**

Pressure rating	1/8" to 1/2": 5000 psi (345 bar) 3/4": 3500 psi (240 bar)
Max. side load rating	FN: 12.5 – 75 in-lb (1.4 – 8.4 Nm) FX: 12.5 – 50 in-lb (1.4 – 5.65 Nm) FNR: 9.38 – 28.13 in-lb (1.06 – 3.18 Nm)
FNV / FNP pilot pressure	65 – 120 psi (4.5 to 8 bar)
FNV / FNP load rating	1/8" female NPT
<b>MATERIALS</b>	
Housing materials	Stainless steel & anodised aluminium
Seal material	NBR

**EXTERNAL THREAD CONNECTORS**

**SQUEEZE LEVER OPERATION**
**CONNECTS TO / SEALS BSPP MALE**

6410

PART NUMBER	CONNECTS TO / SEALS	THREAD	BODY SIZE	PRICE
FASFXL025041	1/8" BSPP	1/4" NPT	1	£1777.27
FASFXL045041	1/4" BSPP	1/4" NPT	1	£1777.27
FASFXL065061	3/8" BSPP	3/8" NPT	2	£1838.60
FASFXL085061	1/2" BSPP	3/8" NPT	2	£1838.60

**CONNECTS TO / SEALS BSPT MALE**

PART NUMBER	CONNECTS TO / SEALS	THREAD	BODY SIZE	PRICE
FASFXL025T041	1/8" BSPT	1/4" NPT	1	£1777.27
FASFXL045T041	1/4" BSPT	1/4" NPT	1	£1777.27
FASFXL065T061	3/8" BSPT	3/8" NPT	2	£1838.60
FASFXL085T061	1/2" BSPT	3/8" NPT	2	£1838.60

**PNEUMATIC PILOT OPERATION**
**CONNECTS TO BSPP MALE**

6410

PART NUMBER	CONNECTS TO / SEALS	THREAD	BODY SIZE	PRICE
FASFXP025041	1/8" BSPP	1/4" NPT	1	£1777.27
FASFXP045041	1/4" BSPP	1/4" NPT	1	£1777.27
FASFXP065061	3/8" BSPP	3/8" NPT	2	£1838.60
FASFXP085061	1/2" BSPP	3/8" NPT	2	£1887.66

**CONNECTS TO BSPT MALE**

PART NUMBER	CONNECTS TO / SEALS	THREAD	BODY SIZE	PRICE
FASFXP025T041	1/8" BSPT	1/4" NPT	1	£1777.27
FASFXP045T041	1/4" BSPT	1/4" NPT	1	£1777.27
FASFXP065T061	3/8" BSPT	3/8" NPT	2	£1838.60
FASFXP085T061	1/2" BSPT	3/8" NPT	2	£1887.66

**PNEUMATIC THUMB VALVE OPERATION**
**CONNECTS TO / SEALS BSPP MALE**

6410

PART NUMBER	CONNECTS TO / SEALS	THREAD	BODY SIZE	PRICE
FASFXV025041	1/8" BSPP	1/4" NPT	1	£1777.27
FASFXV045041	1/4" BSPP	1/4" NPT	1	£1777.27
FASFXV065061	1/4" BSPP	1/4" NPT	2	£1899.92
FASFXV085061	1/2" BSPP	3/8" NPT	2	£1899.92

**CONNECTS TO / SEALS BSPT MALE**

PART NUMBER	CONNECTS TO / SEALS	THREAD	BODY SIZE	PRICE
FASFXV025T041	1/8" BSPT	1/4" NPT	1	£1777.27
FASFXV045T041	1/4" BSPT	1/4" NPT	1	£1777.27
FASFXV065T061	3/8" BSPT	3/8" NPT	2	£1899.92
FASFXV085T061	1/2" BSPT	3/8" NPT	2	£1899.92

**REPLACEMENT SEAL SET**
**SEAL SET**
**5 REPLACEMENT SEALS**
**NBR**

6410

PART NUMBER	FOR USE WITH	PRICE
FASS1105B70	1/8" threads	£40.48
FASS1108B70	1/4" threads	£40.48
FASS1110B70	3/8" threads	£45.38
FASS1112B70	1/2" threads	£46.61

PUR seals available on request

**REPAIR KIT**

6410

**REPAIR KIT**

PART NUMBER	FOR USE WITH	PRICE
FASRFXL021	1/8" threads	£126.33
FASRFXL041	1/4" threads	£126.33
FASRFXL061	3/8" threads	£126.33
FASRFXL081	1/2" threads	£126.33

**INTERNAL THREAD CONNECTORS**

**SQUEEZE LEVER OPERATION  
CONNECTS TO BSPP FEMALE**

6410

PART NUMBER	CONNECTS TO / SEALS	THREAD	BODY SIZE	PRICE
FASFNL026025	1/8" BSPP	1/8" BSPP	1	£1041.34
FASFNL046045	1/4" BSPP	1/4" BSPP	2	£1041.34
FASFNL066065	3/8" BSPP	3/8" BSPP	3	£1102.67
FASFNL086085	1/2" BSPP	1/2" BSPP	4	£1163.99
FASFNL126125	3/4" BSPP	3/4" BSPP	5	£1409.30

**CONNECTS TO BSPT FEMALE**

FASFNL026T025	1/8" BSPT	1/8" BSPP	1	£1041.34
FASFNL046T045	1/4" BSPT	1/4" BSPP	2	£1041.34
FASFNL066T065	3/8" BSPT	3/8" BSPP	3	£1102.67
FASFNL086T085	1/2" BSPT	1/2" BSPP	4	£1163.99
FASFNL126T125	3/4" BSPT	3/4" BSPP	5	£1409.30

**CONNECTS TO METRIC FEMALE**

FASFNL108025	M10 x 1.0	1/8" BSPP	1	£1041.34
FASFNL128045	M12 x 1.5	1/4" BSPP	2	£1163.99
FASFNL148045	M14 x 1.5	1/4" BSPP	2	£1163.99
FASFNL168065	M16 x 1.5	3/8" BSPP	3	£1163.99
FASFNL188065	M18 x 1.5	3/8" BSPP	4	£1286.65
FASFNL208065	M20 x 1.5	3/8" BSPP	4	£1286.65
FASFNL228085	M22 x 1.5	1/2" BSPP	4	£1163.99

**PNEUMATIC THUMB VALVE OPERATION  
CONNECTS TO BSPP FEMALE**

6410

PART NUMBER	CONNECTS TO / SEALS	THREAD	BODY SIZE	PRICE
FASFNV026025	1/8" BSPP	1/8" BSPP	1	£1041.34
FASFNV046045	1/4" BSPP	1/4" BSPP	2	£1041.34
FASFNV066065	3/8" BSPP	3/8" BSPP	3	£1163.99
FASFNV086085	1/2" BSPP	1/2" BSPP	4	£1163.99
FASFNV126125	3/4" BSPP	3/4" BSPP	5	£1163.99

**CONNECTS TO BSPT FEMALE**

FASFNV026T025	1/8" BSPT	1/8" BSPP	1	£1041.34
FASFNV046T045	1/4" BSPT	1/4" BSPP	2	£1041.34
FASFNV066T065	3/8" BSPT	3/8" BSPP	3	£1163.99
FASFNV086T085	1/2" BSPT	1/2" BSPP	4	£1163.99
FASFNV126T125	3/4" BSPT	3/4" BSPP	5	£1163.99

**CONNECTS TO METRIC FEMALE**

FASFNV108025	M10 x 1.0	1/8" BSPP	1	£1163.99
FASFNV128045	M12 x 1.5	1/4" BSPP	2	£1163.99
FASFNV148045	M14 x 1.5	1/4" BSPP	2	£1163.99
FASFNV168065	M16 x 1.5	3/8" BSPP	3	£1163.99
FASFNV188065	M18 x 1.5	3/8" BSPP	4	£1163.99
FASFNV208065	M20 x 1.5	3/8" BSPP	4	£1286.65
FASFNV228085	M22 x 1.5	1/2" BSPP	4	£1286.65

**PNEUMATIC PILOT OPERATION  
CONNECTS TO BSPP FEMALE**

6410

PART NUMBER	CONNECTS TO / SEALS	THREAD	BODY SIZE	PRICE
FASFNP026025	1/8" BSPP	1/8" BSPP	1	£1041.34
FASFNP046045	1/4" BSPP	1/4" BSPP	2	£1041.34
FASFNP066065	3/8" BSPP	3/8" BSPP	3	£1102.67
FASFNP086085	1/2" BSPP	1/2" BSPP	4	£1163.99
FASFNP126125	3/4" BSPP	3/4" BSPP	5	£1409.30

**CONNECTS TO BSPT FEMALE**

FASFNP026T025	1/8" BSPT	1/8" BSPP	1	£1041.34
FASFNP046T045	1/4" BSPT	1/4" BSPP	2	£1078.14
FASFNP066T065	3/8" BSPT	3/8" BSPP	3	£1102.67
FASFNP086T085	1/2" BSPT	1/2" BSPP	4	£1163.99
FASFNP126T125	3/4" BSPT	3/4" BSPP	5	£1409.30

**CONNECTS TO METRIC FEMALE**

FASFNP108025	M10 x 1.0	1/8" BSPP	1	£1041.34
FASFNP128045	M12 x 1.5	1/4" BSPP	2	£1163.99
FASFNP148045	M14 x 1.5	1/4" BSPP	2	£1163.99
FASFNP168065	M16 x 1.5	3/8" BSPP	3	£1041.34
FASFNP188065	M18 x 1.5	3/8" BSPP	4	£1163.99
FASFNP208065	M20 x 1.5	3/8" BSPP	4	£1286.65
FASFNP228085	M22 x 1.5	1/2" BSPP	4	£1163.99

**REPLACEMENT SEAL SET**
**SEAL SET  
5 REPLACEMENT SEALS  
NBR**

6410

PART NUMBER	FOR USE WITH	PRICE
FASS1108B70	1/8" & M10 threads	£40.48
FASS21250327B60	1/4", M12 & M14 threads	£49.06
FASS1112B70	3/8" threads	£46.61
FASS1208B70	1/2" threads	£46.61
FASS1315B50	3/4" threads	£49.06
FASS21200445B70	M16 threads	£46.61
FASS1206B70	M18 threads	£46.61
FASS1207B70	M20 threads	£46.61
FASS1209B70	M22 threads	£49.06

PUR seals available on request



**DESCRIPTION**

TwistMate's unique 'twist to connect' & pressure assisted grip & seal is simple to use. Turn finger-tight onto thread until face seal contacts test piece. TwistMate will automatically seal when the system is pressurised with air, gas or hydraulic pressure that presses the main seal against the test piece. The internal piston action maintains the seal with minimum pressure. TwistMate connectors are not designed for or intended as permanent connections. Such use may result in inadvertent loosening & media loss.

**FEATURES**

- For vacuum or pressure test applications up to 10,000 psi (689 bar)
- Eliminates tape, sealants & operator fatigue from traditional wrenching methods
- Reduces wear on test piece & prevents contamination of media
- Easy to use with operator adjustment necessary
- Rugged stainless steel construction endures demanding production environments

**APPLICATIONS**

- Leak testing – water dunk, pressure decay, helium mass spectrometer
- Calibration, filling, pressure & proof testing
- Ideal for piping, cooling, heating, fluid, hydraulic, pneumatic, refrigerant & fittings
- Eliminates tape, sealants, wrenches & damage to threaded parts
- Durable, easy to replace main seal

**SPECIFICATION**

Connection type	External threads (female)
Connection method	Twist to connect

**MATERIALS**

Seals	Urethane
-------	----------

**MET EXTERNAL THREAD CONNECTORS**
**SWIVEL CONNECTOR**
**CONNECTS TO / SEALS BSPP MALE**

6410

PART NUMBER	CONNECTS TO / SEALS	THREAD	PRESSURE RATING	PRICE
FASMET025025	1/8" BSPP	1/8" BSPP	5000 psi	£337.30
FASMET045045	1/4" BSPP	1/4" BSPP	5000 psi	£361.83
FASMET065065	3/8" BSPP	3/8" BSPP	4000 psi	£337.30
FASMET085085	1/2" BSPP	1/2" BSPP	4000 psi	£263.71

**CONNECTS TO / SEALS BSPT MALE**

FASMET025T025	1/8" BSPT	1/8" BSPP	4000 psi	POA
FASMET045T045	1/4" BSPT	1/4" BSPP	5000 psi	£361.83
FASMET065T065	3/8" BSPT	3/8" BSPP	4000 psi	POA
FASMET085T085	1/2" BSPT	1/2" BSPP	4000 psi	POA

**CAP**
**CONNECTS TO / SEALS BSPP MALE**

6410

PART NUMBER	CONNECTS TO / SEALS	PRESSURE RATING	PRICE
FASMET025C	1/8" BSPP	5000 psi	POA
FASMET045C	1/4" BSPP	5000 psi	£361.83
FASMET065C	3/8" BSPP	4000 psi	£337.30
FASMET085C	1/2" BSPP	4000 psi	£263.71

**CONNECTS TO / SEALS BSPT MALE**

FASMET025TC	1/8" BSPT	5000 psi	POA
FASMET045TC	1/4" BSPT	5000 psi	POA
FASMET065TC	3/8" BSPT	4000 psi	POA
FASMET085TC	1/2" BSPT	4000 psi	£263.71

**MET REPLACEMENT SEAL SET**
**SEAL SET  
5 REPLACEMENT SEALS  
URETHANE**

6410

PART NUMBER	FOR USE WITH	PRICE
FASS1105U70	1/8" threads	£40.48
FASS1108U70	1/4" threads	£40.48
FASS1110U70	3/8" threads	£45.38
FASS1112U70	1/2" threads	£46.61

PUR seals available on request

**MET REPAIR KIT**
**EXTERNAL REPAIR KIT**

6410

PART NUMBER	FOR USE WITH	PRICE
FASMETR02	1/8" threads	£23.30
FASMETR04	1/4" threads	£23.30
FASMETR06	3/8" threads	£28.21
FASMETR08	1/2" threads	£28.21

MIT INTERNAL THREAD CONNECTORS



SWIVEL CONNECTOR

CONNECTS TO / SEALS BSPP FEMALE

6410

PART NUMBER	CONNECTS TO / SEALS	THREAD	PRESSURE RATING	PRICE
FASMIT026025	1/8" BSPP	1/8" BSPP	5000 psi	£431.75
FASMIT046045	1/4" BSPP	1/4" BSPP	5000 psi	POA
FASMIT066065	3/8" BSPP	3/8" BSPP	4000 psi	POA
FASMIT086085	1/2" BSPP	1/2" BSPP	4000 psi	£300.50
FASMIT126125	3/4" BSPP	3/4" BSPP	4000 psi	POA
FASMIT166165	1" BSPP	1" BSPP	4000 psi	POA

CONNECTS TO / SEALS BSPT FEMALE

FASMIT026T025	1/8" BSPT	1/8" BSPT	5000 psi	POA
FASMIT046T045	1/4" BSPT	1/4" BSPT	5000 psi	POA
FASMIT066T065	3/8" BSPT	3/8" BSPT	4000 psi	POA
FASMIT086T085	1/2" BSPT	1/2" BSPT	4000 psi	£300.50
FASMIT126T125	3/4" BSPT	3/4" BSPT	4000 psi	POA
FASMIT166T165	1" BSPT	1" BSPT	4000 psi	POA

CONNECTS TO / SEALS METRIC FEMALE

FASMIT108025	M10 x 1.0	1/8" BSPP	5000 psi	POA
FASMIT128045	M12 x 1.5	1/4" BSPP	5000 psi	POA
FASMIT148045	M14 x 1.5	1/4" BSPP	5000 psi	£440.33
FASMIT168045	M16 x 1.5	3/8" BSPP	4000 psi	POA
FASMIT188065	M18 x 1.5	3/8" BSPP	4000 psi	£466.09
FASMIT228085	M22 x 1.5	1/2" BSPP	4000 psi	£459.96



PLUG

CONNECTS TO / SEALS BSPP FEMALE

6410

PART NUMBER	CONNECTS TO / SEALS	PRESSURE RATING	PRICE
FASMIT026P	1/8" BSPP	5000 psi	£214.65
FASMIT046P	1/4" BSPP	5000 psi	£182.76
FASMIT066P	3/8" BSPP	4000 psi	£244.08
FASMIT086P	1/2" BSPP	4000 psi	£294.37
FASMIT126P	3/4" BSPP	4000 psi	£366.74
FASMIT166P	1" BSPP	4000 psi	£550.72

CONNECTS TO / SEALS FEMALE BSPT THREAD

FASMIT026TP	1/8" BSPT	5000 psi	POA
FASMIT046TP	1/4" BSPT	5000 psi	£182.76
FASMIT066TP	3/8" BSPT	4000 psi	£244.08
FASMIT086TP	1/2" BSPT	4000 psi	£300.50
FASMIT126TP	3/4" BSPT	4000 psi	£509.02
FASMIT166TP	1" BSPT	4000 psi	£526.19

CONNECTS TO / SEALS FEMALE METRIC THREAD

FASMIT108P	M10 x 1.0	5000 psi	£275.97
FASMIT128P	M12 x 1.5	5000 psi	£248.99
FASMIT148P	M14 x 1.5	5000 psi	£440.33
FASMIT168P	M16 x 1.5	4000 psi	£244.08
FASMIT188P	M18 x 1.5	4000 psi	£466.09
FASMIT228P	M22 x 1.5	4000 psi	£398.63



NON-SWIVEL CONNECTOR

CONNECTS TO / SEALS BSPP FEMALE

6410

PART NUMBER	CONNECTS TO / SEALS	THREAD	PRESSURE RATING	PRICE
FASMIT026025X	1/8" BSPP	1/8" BSPP	5000 psi	£219.55
FASMIT046045X	1/4" BSPP	1/4" BSPP	5000 psi	£182.76
FASMIT066065X	3/8" BSPP	3/8" BSPP	4000 psi	£280.88
FASMIT086085X	1/2" BSPP	1/2" BSPP	4000 psi	£300.50
FASMIT126125X	3/4" BSPP	3/4" BSPP	4000 psi	£366.74
FASMIT166165X	1" BSPP	1" BSPP	4000 psi	£550.72

CONNECTS TO / SEALS BSPT FEMALE

FASMIT026T025X	1/8" BSPT	1/8" BSPT	5000 psi	POA
FASMIT046T045X	1/4" BSPT	1/4" BSPT	5000 psi	POA
FASMIT066T065X	3/8" BSPT	3/8" BSPT	4000 psi	£244.08
FASMIT086T085X	1/2" BSPT	1/2" BSPT	4000 psi	£300.50
FASMIT126T125X	3/4" BSPT	3/4" BSPT	4000 psi	£376.55
FASMIT166T165X	1" BSPT	1" BSPT	4000 psi	£550.72

MIT REPLACEMENT SEAL SET



SEAL SET  
5 REPLACEMENT SEALS  
URETHANE

6410

PART NUMBER	FOR USE WITH	PRICE
FASS1109U70	1/8" threads	£40.48
FASS1111U70	1/4" threads	£45.38
FASS1113U70	3/8" threads	£46.61
FASS1209U70	1/2" threads	£49.06

PUR seals available on request

MIT REPAIR KIT



INTERNAL REPAIR KIT  
FOR SWIVEL CONNECTOR

6410

PART NUMBER	FOR USE WITH	PRICE
FASMITR020	1/8" & M10 threads	£20.85
FASMITR040	1/4" & M12 threads	£20.85
FASMITR060	3/8" & M14 threads	£20.85
FASMITR080	1/2" & M16 threads	£20.85
FASMITR120	3/4" & M18 threads	£26.98
FASMITR160	1" & M22 threads	£29.44

FOR NON-SWIVEL CONNECTOR

FASMITR02	1/8" threads	£17.17
FASMITR04	1/4" threads	£17.17
FASMITR06	3/8" threads	£17.17
FASMITR08	1/2" threads	£17.17
FASMITR12	3/4" threads	£19.62
FASMITR16	1" threads	£20.85
FASMITR20	1 1/4" threads	£26.98